

FEATURES

- 1). High current rating
- 2). Excellent dynamic characteristics
- 3). $dv/dt = 1000V/\mu s$ option
- 4). Superior surge capabilities
- 5). Standard package
- 6). Metric threads version available
- 7). Types up to 1600V V_{DRM}/V_{RRM}

TYPICAL APPLICATIONS

- 1). Phase control applications in converters
- 2). Lighting circuits
- 3). Battery charges
- 4). Regulated power supplies and temperature and speed control circuit
- 5). Can be supplied to meet stringent military, aerospace and other high-reliability requirements

MAJOR RATINGS AND CHARACTERISTICS

Parameters		K50RIA		Unit
		10 to 120	140 to 160	
$I_{F(AV)}$		50	50	A
	@ T_C	94	90	°C
$I_{F(RMS)}$		80	80	A
I_{FSM}	@ 50Hz	1430	1200	A
	@ 60Hz	1490	1257	A
i^2t	@ 50Hz	10.18	7.21	KA ² s
	@ 60Hz	9.30	6.58	A ² s
V_{DRM}/V_{RRM}		100 to 1200	1400 to 1600	V
T_q	typical	110		μ s
T_J		- 40 to 125		°C

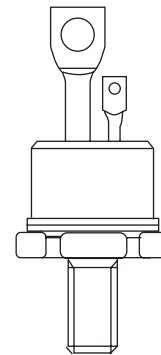

ELECTRICAL SPECIFICATIONS

1). Voltage Ratings

Type number	Voltage Code	V_{DRM}/V_{RRM} , maximum repetitive peak reverse voltage *(1)	V_{RSM} , maximum non-repetitive peak reverse voltage *(2)	I_{DRM}/I_{RRM} max. @ $T_J = T_{J\ max}$
		V	V	mA
K50RIA	10	100	150	15
	20	200	300	
	40	400	500	
	60	600	700	
	80	800	900	
	100	1000	1100	
	120	1200	1300	
	140	1400	1500	
	160	1600	1700	

*(1) Units may be broken over non-repetitively in the off-state direction without damage, if di/dt does not exceed 20A/μ s

*(2) For voltage pulses with $tp \leq 5ms$

2). Forward Conduction

Parameters		K50RIA		Unit	Conditions		
		10 to 120	140 to 160				
I _{T(AV)}	Max. average forward current	50	50	A	180° conduction, half sine wave		
	@ Case temperature	94	90	°C			
I _{T(RMS)}	Max. RMS forward current	80	80	A			
I _{TSM}	Max. peak, one-cycle forward, non-repetitive surge current	1430	1200	A	t = 10ms	No voltage	Sinusoidal half wave, Initial T _J = T _J max.
		1490	1257		t = 8.3ms	reapplied	
		1200	1010		t = 10ms	100% V _{RRM}	
		1255	1057		t = 8.3ms	reapplied	
I ² t	Maximum I ² t for fusing	10.18	7.21	KA ² s	t = 10ms	No voltage	
		9.30	6.58		t = 8.3ms	reapplied	
		7.20	5.10		t = 10ms	100% V _{RRM}	
		6.56	4.65		t = 8.3ms	reapplied	
I ² √t	Maximum I ² √t for fusing	101.8	72.1	KA ² √s	t = 0.1 to 10ms, no voltage reapplied		
V _{T(TO)1}	Low level value of threshold voltage	0.94	1.02	V	(16.7% × π × I _{F(AV)}) < I < π × I _{F(AV)} , T _J = T _J max.		
V _{T(TO)2}	High level value of threshold voltage	1.08	1.17	V	(I > π × I _{F(AV)}), T _J = T _J max.		
r _{T1}	Low level value of forward slope resistance	4.08	4.78	mΩ	(16.7% × π × I _{F(AV)}) < I < π × I _{F(AV)} , T _J = T _J max.		
r _{T2}	High level value of forward slope resistance	3.34	3.97	mΩ	(I > π × I _{F(AV)}), T _J = T _J max.		
V _{TM}	Max. forward voltage drop	1.60	1.78	V	I _{pk} = 50A, T _J = 25°C t _p = 10ms sine pulse		
I _H	Maximum holding current	200		mA	T _J = 25° C, anode supply 12V resistive load		
I _L	Typical latching current	400					
di/dt	Max. rate of rise of turned-on current			A/μs	T _C = 125°C, V _{DM} = rated V _{DRM}		
	V _{DRM} ≤ 600V	200			Gate pulse = 20V, 15Ω, t _p = 6 μs, tr = 0.1 μs max. I _{TM} = (2x rated di/dt) A		
	V _{DRM} ≤ 1600V	100					
t _d	Typical delay time	0.9		μs	T _C = 25°C V _{DM} = rated V _{DRM} I _{TM} = 10A dc resistive circuit Gate pulse = 10V, 15Ω source, t _p = 20 μs		
t _q	Typical turn-off time	110			TC = 125°C, ITM = 50A, reapplied dv/dt = 20V/μs dir/dt = -10A/μs, VR=50V		
dv/dt	Max. critical rate of rise of	200		V/μs	T _J = T _J max. linear to 100% rated V _{DRM}		
	off-state voltage	500(*)			T _J = T _J max. linear to 67% rated V _{DRM}		

(*) Available with: dv/dt = 1000V/μs, to complete code add S90 i.e. K50RIA120S90.

3). Triggering

Parameters		K50RIA	Unit	Conditions		
P_{GM}	Maximum peak gate power	10	W	$T_J = T_J \text{ max.}$		
$P_{G(AV)}$	Maximum average gate power	2.5				
I_{GM}	Max. peak positive gate current	2.5	A	$T_J = T_J \text{ max.}$		
$+V_{GM}$	Max. peak positive gate current	20	V	$T_J = T_J \text{ max.}$		
$-V_{GM}$	Maximum peak positive gate voltage	10				
I_{GT}	DC gate current required to trigger	250	mA	$T_J = -40^\circ\text{C}$	Max. required gate trigger current/voltage are the lowest value which will trigger all units 6V anode-to-cathode applied	
		100		$T_J = 25^\circ\text{C}$		
		50		$T_J = 125^\circ\text{C}$		
V_{GT}	DC gate voltage required to trigger	3.5	V	$T_J = -40^\circ\text{C}$		
		2.5		$T_J = 25^\circ\text{C}$		
I_{GD}	DC gate current not to trigger	5.0	mA	$T_J = T_J \text{ max.}$		Max. gate current/ voltage not to trigger is the max. value which. will not trigger any unit with rated V_{DRM} anode-to-cathode applied
				$V_{DRM} = \text{rated value}$		
V_{GD}	DC gate voltage not to trigger	0.2	V	$T_J = T_J \text{ max.}$		
T_J	Max. operating temperature range	- 40 to 125	$^\circ\text{C}$			
T_{stg}	Max. storage temperature range	- 40 to 125	$^\circ\text{C}$			
R_{thJC}	Max. thermal resistance, junction to case	0.35	K/W	DC operation		
R_{thCS}	Max. thermal resistance, case to heatsink	0.25	K/W	Mounting surface, smooth, flat and greased		
T	Mounting torque	Min.	2.8 (25)	Nm	Non-lubricated threads	
		Max.	3.4 (30)	lbf-in		
wt	Approximate weight	28 (1.0)	g (oz)			
	Case style	TO-65		See Outline Table		

ΔR_{thJC} Conduction

(The following table shows the increment of thermal resistance R_{thJC} when devices operate at different conduction angles than DC)

Conduction angle	Sinusoidal conduction	Rectangular conduction	Units	Conditions
180°	0.078	0.057	K/W	$T_J = T_J \text{ max.}$
120°	0.094	0.098		
90°	0.120	0.130		
60°	0.176	0.183		
30°	0.294	0.296		

PERFORMANCE CURVES FIGURE

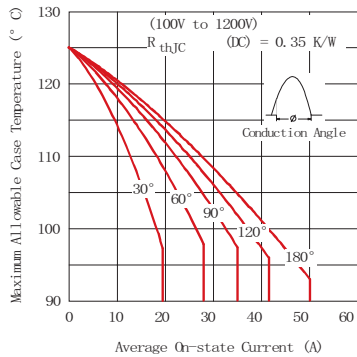

Fig. 1 - Current Ratings Characteristic

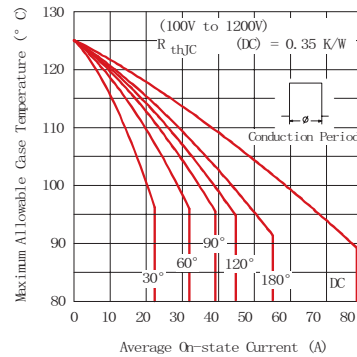

Fig. 2 - Current Ratings Characteristic

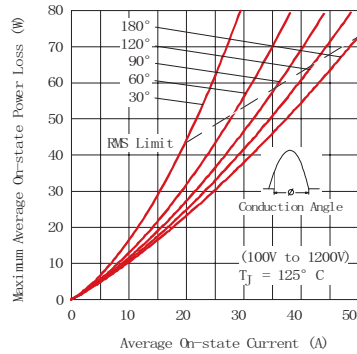

Fig. 3 - On-state Power Loss Characteristics

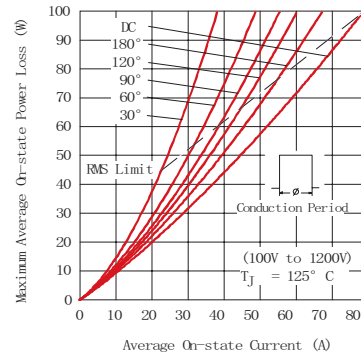

Fig. 4 - On-state Power Loss Characteristics

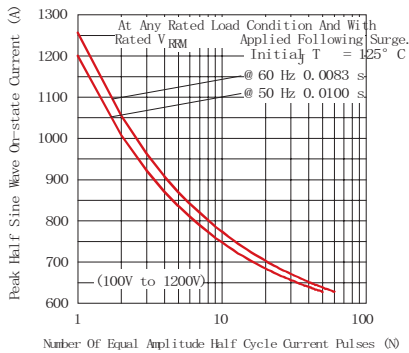

Fig. 5 - Maximum Non-Repetitive Surge Current

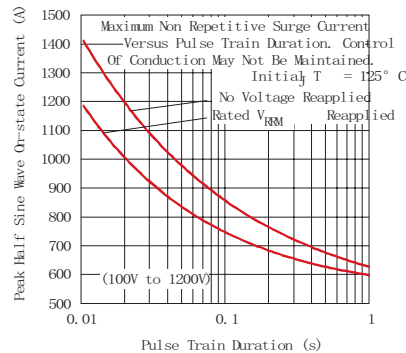

Fig. 6 - Maximum Non-Repetitive Surge Current

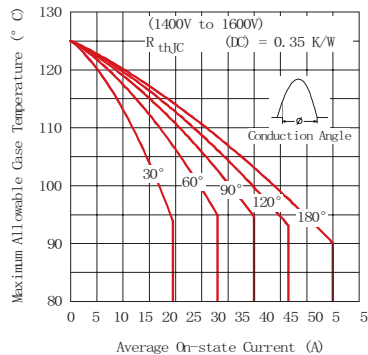

Fig. 7 - Current Ratings Characteristics

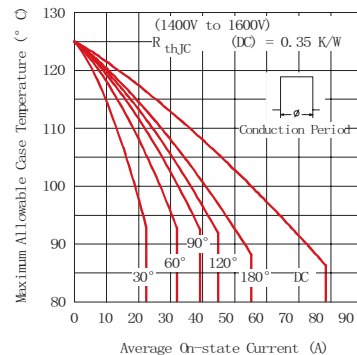

Fig. 8 - Current Ratings Characteristics

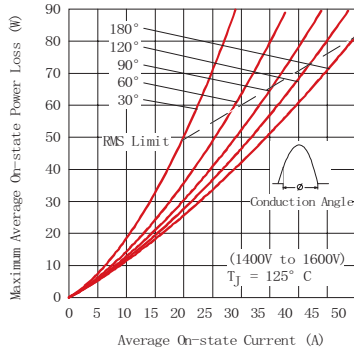

Fig. 9 - On-state Power Loss Characteristics

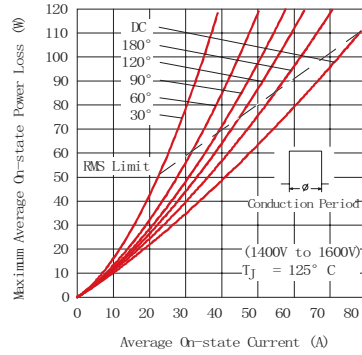

Fig. 10 - On-state Power Loss Characteristics

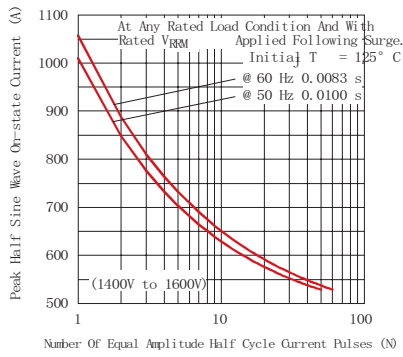

Fig. 11 - Maximum Non-Repetitive Surge Current

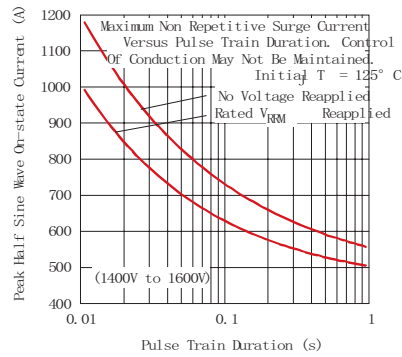

Fig. 12 - Maximum Non-Repetitive Surge Current

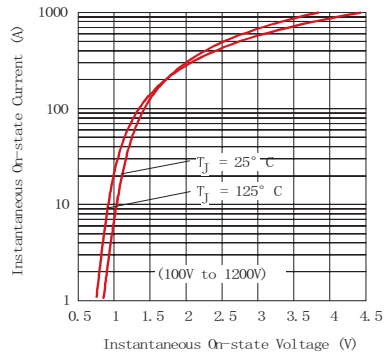

Fig. 13 - Forward Voltage Drop Characteristics

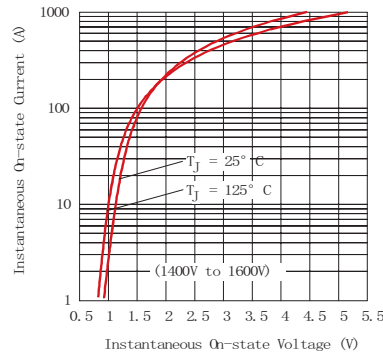

Fig. 14 - Forward Voltage Drop Characteristics

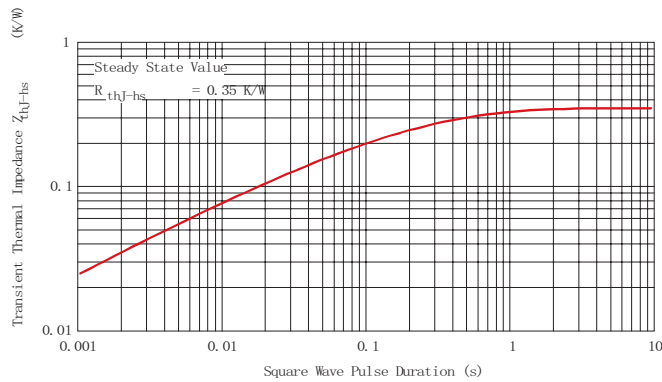

Fig. 15 - Thermal Impedance Z_{thJC} Characteristics

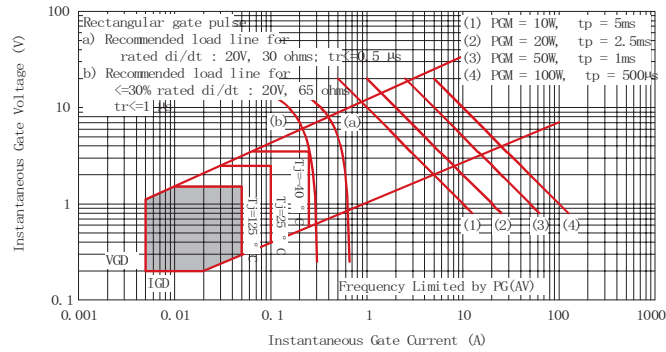
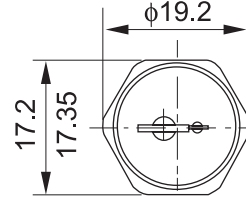
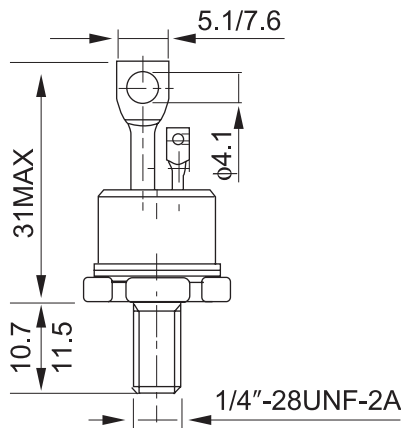

Fig. 16 - Gate Characteristics

OUTLINE



*FOR METRIC DEVICE:M6×1

Case Style TO-65

YUEQING LIUJING RECTIFIER CO., LTD

Sale Department: Liujing Building, Yueqing City,
Zhejiang Province

Add: Wanao Industrial Zone, Yueqing city,
Zhejiang Province

Tel: 0086-577-62519692 0089-577-62519693

Fax: 0086-577-62518692

International Export: 0086-577-62571902

Technical Support: 0086-15868768965

After Service: 400-6606-086

<http://www.china-liujing.com>

<http://www.liujingdianqi.cn>

<http://www.cnrectifier.com>

<http://www.cnthyristor.com.cn>

MSN: thristors@hotmail.com

打造最具竞争力的电力半导体产品

To be the most competitive Power Semiconductor
Devices manufactory.

LIUJING reserves the right to change limits, test conditions and dimensions.

윤정은 이 칼타로그 중에 데이트, 테스트 조건, 외형사이에 대한 최종 해석권을 가지고 있습니다.