

FEATURES

- 1). Diffused diode
- 2). Wide current range
- 3). High voltage ratings up to 1200V
- 4). High surge current capabilities
- 5). Stud cathode and stud anode version
- 6). Hermetic metal case

TYPICAL APPLICATIONS

- 1). Welders
- 2). Power supplies
- 3). Machine tool controls
- 4). High power drives
- 5). Medium traction applications
- 6). Battery charges
- 7). Free-wheeling diodes

MAJOR RATINGS AND CHARACTERISTICS

Parameters		150U(R)	UNIT
$I_{F(AV)}$		150	A
	@ TC	125	°C
$I_{F(RMS)}$		235	A
I_{FSM}	@ 50Hz	3000	A
	@ 60Hz	3140	A
I^2t	@ 50Hz	45	A ² s
	@ 60Hz	41	A ² s
V_{RRM}	range	600 and 1200	V
T_J	range	- 40 to 180	°C

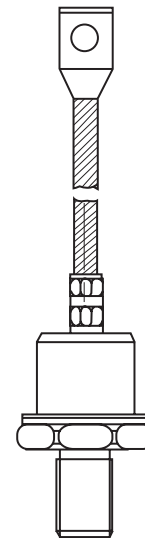

ELECTRICAL SPECIFICATIONS

1). Voltage Ratings

Type number	Voltage Code	V_{RRM} , maximum repetitive peak reverse voltage	V_{RSM} , maximum non-repetitive peak reverse voltage	I_{RRM} max. @ $T_J = T_{J \text{ max}}$
		V	V	mA
150U(R)	60	600	700	15
	80	800	900	
	100	1000	1100	
	120	1200	1300	

2). Forward Conduction

Parameters		150U(R)	Unit	Conditions		
$I_{F(AV)}$	Max. average forward current	150	A	180° conduction, half sine wave		
	@ Case temperature	125	°C			
$I_{F(RMS)}$	Max. RMS forward current	235	A	Dc @ 110°C		
I_{FSM}	Max. peak, one-cycle forward, non-repetitive surge current	3000	A	t = 10ms	No voltage	Sinusoidal half wave, Initial $T_J = T_J$ max.
		3140		t = 8.3ms	reapplied	
I^2t	Maximum I^2t for fusing	45	KA ² s	t = 10ms	No voltage	
		41		t = 8.3ms	reapplied	
$I^2\sqrt{t}$	Maximum $I^2\sqrt{t}$ for fusing	-	KA ² \sqrt{s}	t = 0.1 to 10ms, no voltage reapplied		
r_f	Slope resistance	0.97	mΩ	@ $T_J = T_J$ max.		
$V_{F(TO)}$	Threshold voltage	0.80	V			
V_{FM}	Max. forward voltage drop	1.47	V	$I_{pk} = 600A, T_J = 25°C, t_p = 10ms$ sinusoidal wave		
T_J	Max. junction operating temperature range	-40 to 180	°C			
T_{stg}	Max. storage temperature range	-40 to 180				
R_{thJC}	Max. thermal resistance, junction to case	0.3	K/W	DC operation		
R_{thCS}	Max. thermal resistance, case to heatsink	0.1		Mounting surface, smooth, flat and greased		
T	Max. allowed mounting torque +0 -20%	17	Nm	Not lubricated threads		
		14.5		Lubricated threads		
wt	Approximate weight	130	g			
	Case style	DO-8		See Outline Table		

ΔR_{thJC} Conduction

(The following table shows the increment of thermal resistance R_{thJC} when devices operate at different conduction angles than DC)

Conduction angle	Sinusoidal conduction	Rectangular conduction	Units	Conditions
180°	0.031	0.023	K/W	$T_J = T_J$ max.
120°	0.038	0.040		
90°	0.048	0.053		
60°	0.071	0.075		
30°	0.120	0.121		

PERFORMANCE CURVES FIGURE

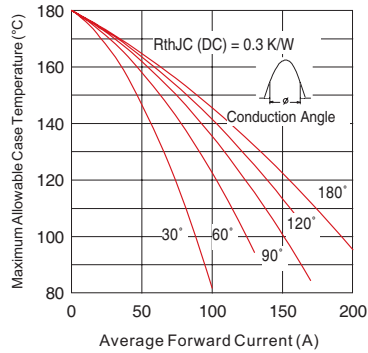

Fig. 1 - Current Ratings Characteristics

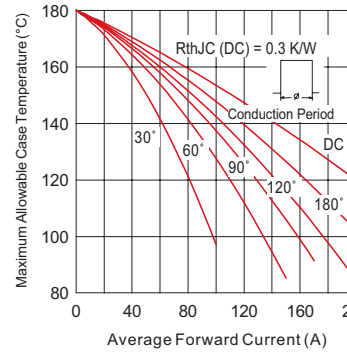

Fig. 2 - Current Ratings Characteristic

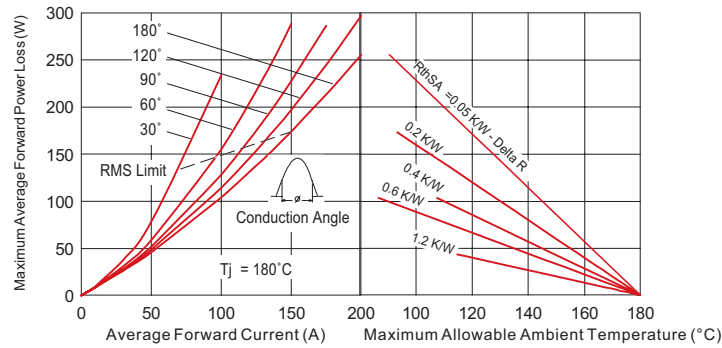

Fig. 3 - Forward Power Loss Characteristics

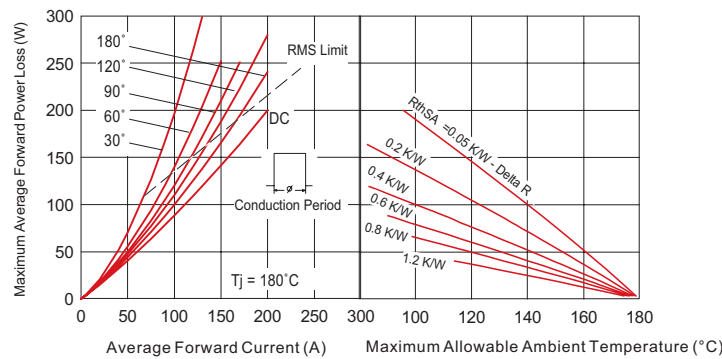

Fig. 4 - Forward Power Loss Characteristics

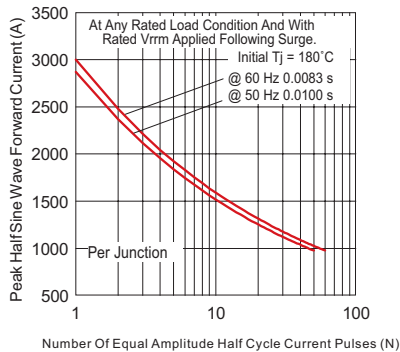

Fig. 5 - Maximum Non-Repetitive Surge Current

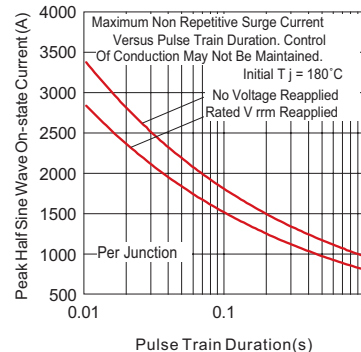

Fig. 6 - Maximum Non-Repetitive Surge Current

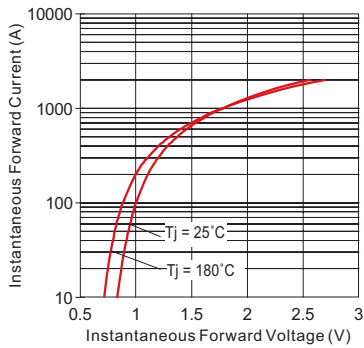

Fig. 7 - Forward Voltage Drop Characteristics

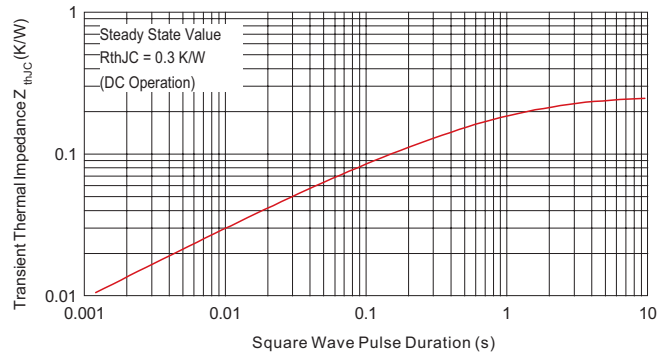
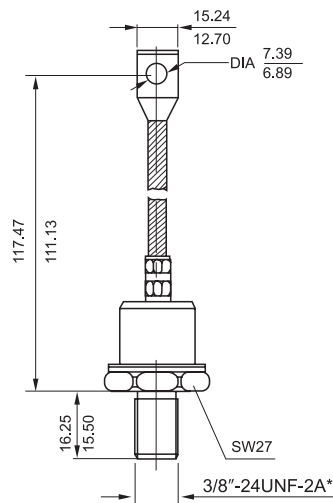

Fig. 8 - Thermal Impedance Z_{thJC} Characteristic

OUTLINE



For metric device: M12X1.75
Case Style DO-8

YUEQING LIUJING RECTIFIER CO., LTD

Sale Department: Liujing Building, Yueqing City,
Zhejiang Province

Add: Wanao Industrial Zone, Yueqing city,
Zhejiang Province

Tel: 0086-577-62519692 0089-577-62519693

Fax: 0086-577-62518692

International Export: 0086-577-62571902

Technical Support: 0086-15868768965

After Service: 400-6606-086

<http://www.china-liujing.com>

<http://www.liujingdianqi.cn>

<http://www.cnrectifier.com>

<http://www.cnthyristor.com.cn>

MSN: thristors@hotmail.com

打造最具竞争力的电力半导体产品

To be the most competitive Power Semiconductor
Devices manufactory.

LIUJING reserves the right to change limits, test conditions and dimensions.

윤정은 이 칼타로그 중에 데이트, 테스트 조건, 외형사이즈에 대한 최종 해석권을 가지고 있습니다.