

### 特点

- 1). 芯片与底板电气绝缘, 2500V交流绝缘
- 2). 全压接结构, 优良的温度特性和功率循环能力
- 3). 体积小, 重量轻

### 典型应用

- 1). 交直流电机控制
- 2). 各种整流电源
- 3). 变频器

$I_{T(AV)}$	500A
$V_{DRM}/V_{RRM}$	600~18000V
$I_{TSM}$	$16 A \times 10^3$
$I^2t$	$1280 A^2S \times 10^3$

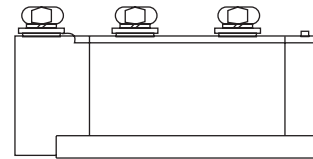

### 主要参数

符号	参数	测试条件	结温 $T_j(^\circ C)$	参数值			单位
				最小	典型	最大	
$I_{T(AV)}$	通态平均电流	$180^\circ$ 正弦半波, 50Hz单面散热, $T_c=85^\circ C$	125			500	A
$I_{T(RMS)}$	方均根电流		125			785	A
$V_{DRM}$ $V_{RRM}$	断态重复峰值电压 反向重复峰值电压	$V_{DRM} \& V_{RRM} \quad tp=10ms$ $V_{DSM} \& V_{RSM} = V_{DRM} \& V_{RRM} + 200V$	125	600		1800	V
$I_{DRM}$ $I_{RRM}$	断态重复峰值电流 反向重复峰值电流	$V_{DM} = V_{DRM}$ $V_{RM} = V_{RRM}$	125			50	mA
$I_{TSM}$	通态不重复浪涌电流	10ms 正弦半波	125			16.0	KA
$I^2t$	浪涌电流平方时间积	$V_R = 0.6V_{RRM}$				1280	$A^2s \times 10^3$
$V_{TO}$	门槛电压		125			0.80	V
$r_T$	斜率电阻		125			0.34	m $\Omega$
$V_{TM}$	通态峰值电压	$I_{TM} = 1500A$	25			1.44	V
dv/dt	断态电压临界上升率	$V_{DM} = 67\%V_{DRM}$	125			800	V/ $\mu s$
di/dt	通态电流临界上升率	$I_{TM} = 1000A$ , 门极触发电流幅值 $I_{GM} = 1.5A$ , 门极上升时间 $tr \leq 0.5 \mu s$	125			100	A/ $\mu s$
$I_{GT}$	门极触发电流			30		200	mA
$V_{GT}$	门极触发电压	$V_A = 12V, I_A = 1A$	25	1.0		3.0	V
$I_H$	维持电流			20		200	mA
$V_{GD}$	门极不触发电压	At $67\%V_{DRM}$	125	0.2			V
$R_{th(j-c)}$	热阻抗(结至壳)	$180^\circ$ 正弦波, 单面散热				0.065	$^\circ C/W$
$R_{th(c-h)}$	热阻抗(壳至散)	$180^\circ$ 正弦波, 单面散热				0.024	$^\circ C/W$
$V_{iso}$	绝缘电压	50Hz, R.M.S, $t=1min, I_{iso}: 1mA(MAX)$		2500			V
$F_m$	安装扭矩(M10)				12		N·m
	安装扭矩(M6)				6		N·m
$T_{stg}$	贮存温度			-40		125	$^\circ C$
$W_t$	质量	外形为501F			2300		g
Size	包装盒尺寸				140 × 68 × 68 (1只装)		mm

性能曲线图

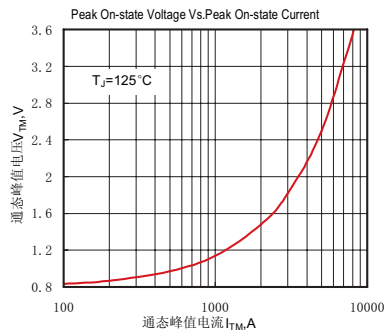

Fig.1 通态伏安特性曲线

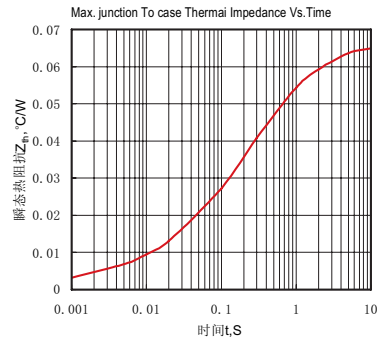

Fig.2 结至管壳瞬态热阻抗曲线

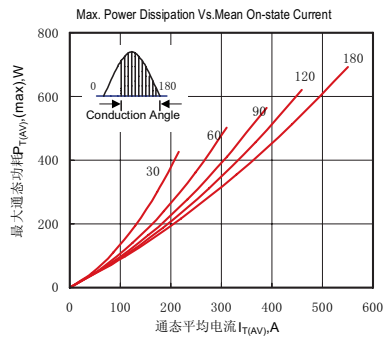

Fig.3 最大功耗与平均电流关系曲线

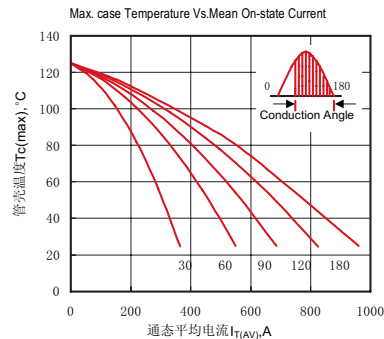

Fig.4 管壳温度与通态平均电流关系曲线

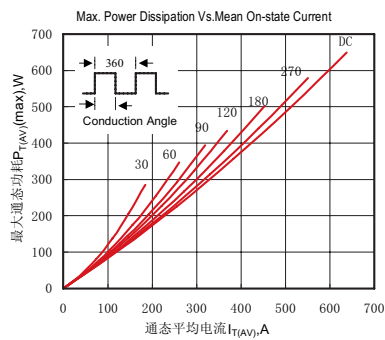

Fig.5 最大功耗与平均电流关系曲线

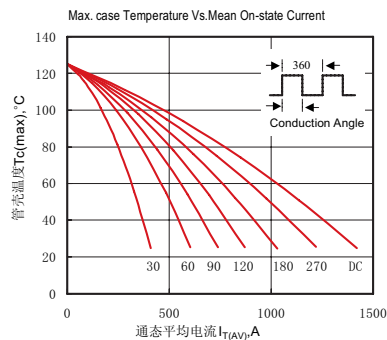

Fig.6 管壳温度与通态平均电流关系曲线

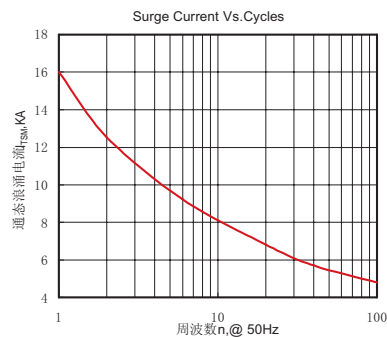

Fig.7 通态浪涌电流与周波数的关系曲线

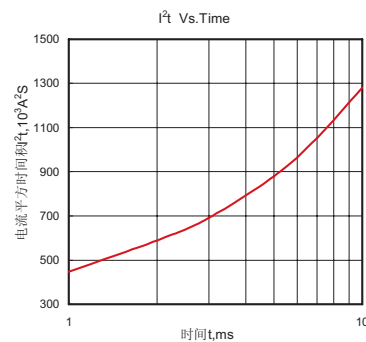

Fig.8 I²t特性曲线

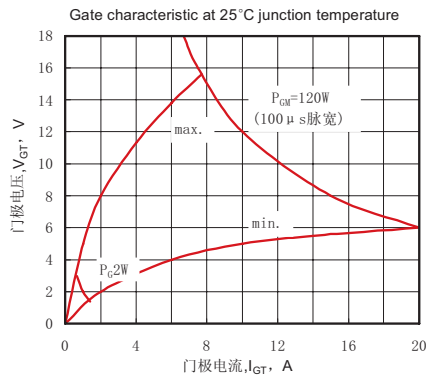

Fig.9 门极功率曲线

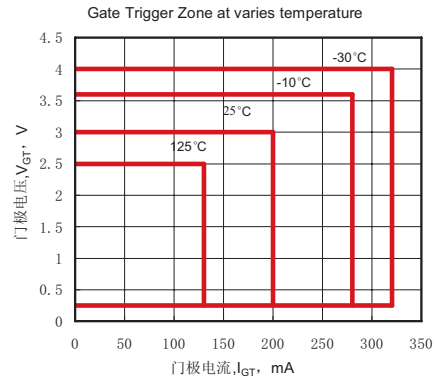
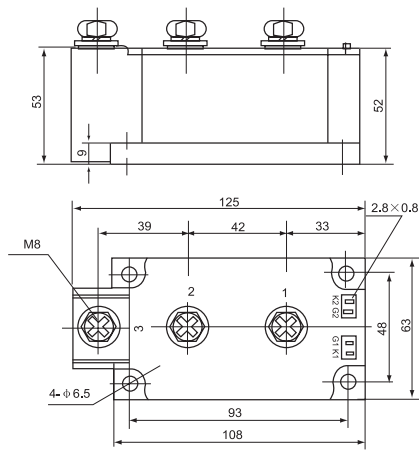
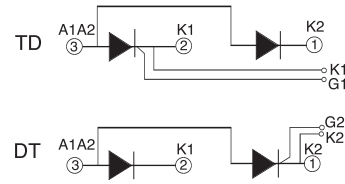

Fig.10 门极触发特性曲线

外形尺寸图



501F



YUEQING LIUJING RECTIFIER CO., LTD

Sale Department: Liujing Building, Yueqing City, Zhejiang Province  
 Add: Wanao Industrial Zone, Yueqing city, Zhejiang Province  
 Tel: 0086-577-62519692 0089-577-62519693  
 Fax: 0086-577-62518692  
 International Export: 0086-577-62571902  
 Technical Support: 0086-15868768965  
 After Service: 400-6606-086  
<http://www.china-liujing.com>  
<http://www.liujingdianqi.cn>  
<http://www.cnrectifier.com>  
<http://www.cnthyristor.com.cn>  
 MSN: thristors@hotmail.com

打造最具竞争力的电力半导体产品

To be the most competitive Power Semiconductor Devices manufactory.

LIUJING reserves the right to change limits, test conditions and dimensions.

윤정은 이 칼타로그 중에 데이트, 테스트 조건, 외형사이즈에 대한 최종 해석권을 가지고 있습니다.