

特点

- 1). 芯片与底板电气绝缘, 2500V交流绝缘
- 2). 全压接结构, 优良的温度特性和功率循环能力
- 3). 体积小, 重量轻

典型应用

- 1). 交直流电机控制
- 2). 各种整流电源
- 3). 变频器

$I_{T(AV)}$	800A
V_{DRM}/V_{RRM}	600~1800V
I_{TSM}	$16 A \times 10^3$
I^2t	$1280 A^2S \times 10^3$

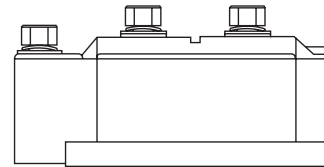

主要参数

符号	参数	测试条件	结温 $T_j(^\circ C)$	参数值			单位
				最小	典型	最大	
$I_{T(AV)}$	通态平均电流	180° 正弦半波, 50Hz单面散热, $T_c=85^\circ C$	125			800	A
$I_{T(RMS)}$	方均根电流		125			1256	A
V_{DRM} V_{RRM}	断态重复峰值电压 反向重复峰值电压	$V_{DRM} \& V_{RRM} \quad tp=10ms$ $V_{DSM} \& V_{RSM} = V_{DRM} \& V_{RRM} + 200V$	125	600		1800	V
I_{DRM} I_{RRM}	断态重复峰值电流 反向重复峰值电流	$V_{DM} = V_{DRM}$ $V_{RM} = V_{RRM}$	125			40	mA
I_{TSM}	通态不重复浪涌电流	10ms 正弦半波	125			16.0	KA
I^2t	浪涌电流平方时间积	$V_R=0.6V_{RRM}$	125			1280	$A^2s \times 10^3$
V_{TO}	门槛电压		125			0.80	V
r_T	斜率电阻		125			0.42	$m\Omega$
V_{TM}	通态峰值电压	$I_{TM}=2400A$	25			1.86	V
dv/dt	断态电压临界上升率	$V_{DM}=67\%V_{DRM}$	125			800	$V/\mu s$
di/dt	通态电流临界上升率	$I_{TM}=1600A$, 门极触发电流幅值 $I_{GM}=1.5A$, 门极上升时间 $tr \leq 1 \mu s$	125			100	$A/\mu s$
I_{GT}	门极触发电流			30		200	mA
V_{GT}	门极触发电压	$V_A=12V, I_A=1A$	25	1.0		3.0	V
I_H	维持电流			20		200	mA
V_{GD}	门极不触发电压	At $67\%V_{DRM}$	125	0.2			V
$R_{th(j-c)}$	热阻抗(结至壳)	180° 正弦波, 单面散热				0.054	$^\circ C/W$
V_{iso}	绝缘电压	50Hz, R.M.S, $t=1min, I_{iso}:1mA(MAX)$		2500			V
F_m	安装扭矩(M12)				14		N·m
	安装扭矩(M8)				12		N·m
T_{slg}	贮存温度			-40		125	$^\circ C$
W_t	质量	外形为701F			3500		g
Size	包装盒尺寸	200 × 82 × 100 (1只装)					mm

性能曲线图

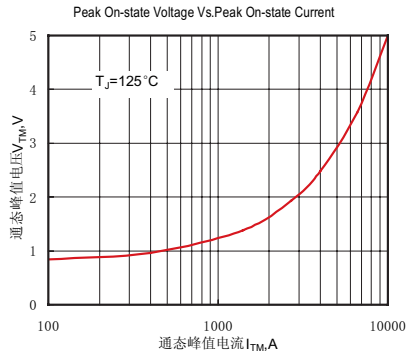

Fig.1 通态伏安特性曲线

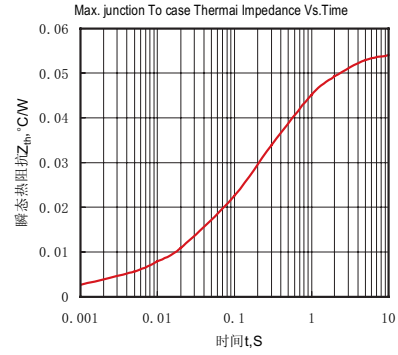

Fig.2 结至管壳瞬态热阻抗曲线

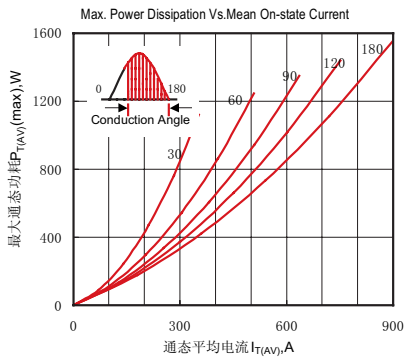

Fig.3 最大功耗与平均电流关系曲线

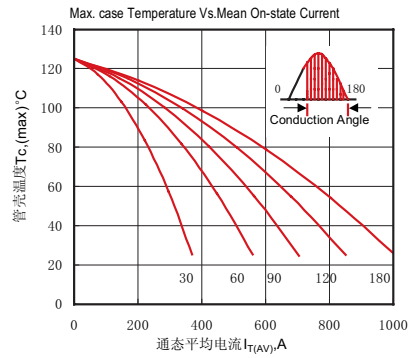

Fig.4 管壳温度与通态平均电流关系曲线

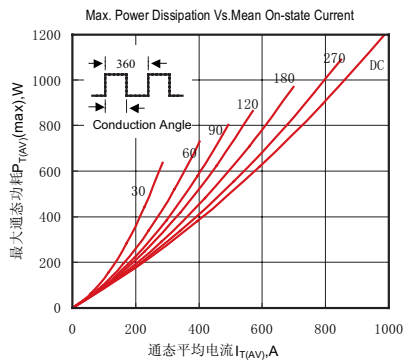

Fig.5 最大功耗与平均电流关系曲线

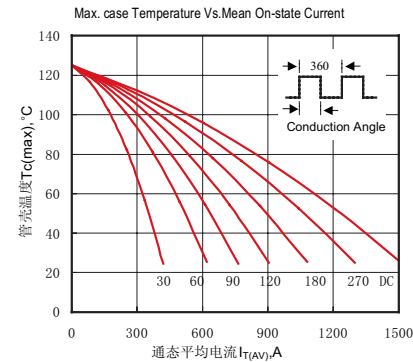

Fig.6 管壳温度与通态平均电流关系曲线

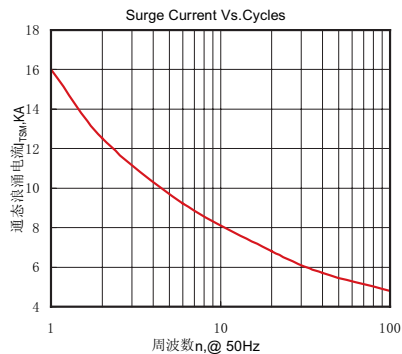

Fig.7 通态浪涌电流与周波数的关系曲线

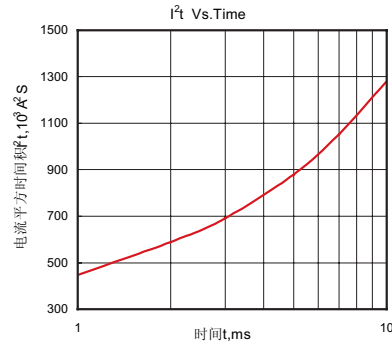

Fig.8 I²t特性曲线

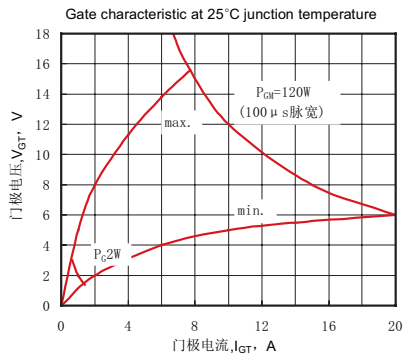

Fig.9 门极功率曲线

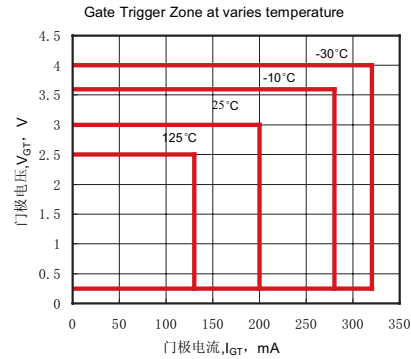
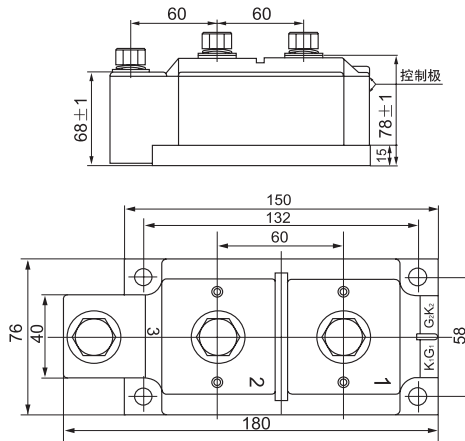
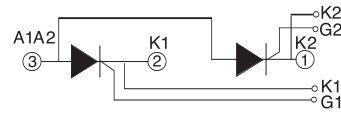

Fig.10 门极触发特性曲线

外形尺寸图



701F



YUEQING LIUJING RECTIFIER CO., LTD

Sale Department: Liujing Building, Yueqing City, Zhejiang Province
 Add: Wanao Industrial Zone, Yueqing city, Zhejiang Province
 Tel: 0086-577-62519692 0089-577-62519693
 Fax: 0086-577-62518692
 International Export: 0086-577-62571902
 Technical Support: 0086-15868768965
 After Service: 400-6606-086
<http://www.china-liujing.com>
<http://www.liujingdianqi.cn>
<http://www.cnrectifier.com>
<http://www.cnthyristor.com.cn>
 MSN: thristors@hotmail.com

打造最具竞争力的电力半导体产品

To be the most competitive Power Semiconductor Devices manufactory.

LIUJING reserves the right to change limits, test conditions and dimensions.

윤정은 이 칼타로그 중에 데이트, 테스트 조건, 외형사이즈에 대한 최종 해석권을 가지고 있습니다.