

特点

- 1). 芯片与底板电气绝缘, 2500V交流绝缘
- 2). 全压接结构, 优良的温度特性和功率循环能力
- 3). 体积小, 重量轻

典型应用

- 1). 交直流电机控制
- 2). 各种整流电源
- 3). 变频器

| | |
|-------------------|------------------------|
| $I_{T(AV)}$ | 160A |
| V_{DRM}/V_{RRM} | 600~1800V |
| I_{TSM} | $5.4 A \times 10^3$ |
| I^2t | $146 A^2S \times 10^3$ |

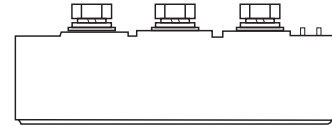

主要参数

| 符号 | 参数 | 测试条件 | 结温 $T_j(^\circ C)$ | 参数值 | | | 单位 |
|------------------------|----------------------|--|-----------------------|------|-----|-------|--------------------|
| | | | | 最小 | 典型 | 最大 | |
| $I_{T(AV)}$ | 通态平均电流 | 180° 正弦半波, 50Hz 单面散热, $T_c=85^\circ C$ | 125 | | | 160 | A |
| $I_{T(RMS)}$ | 方均根电流 | | 125 | | | 251 | A |
| V_{DRM} V_{RRM} | 断态重复峰值电压 反向重复峰值电压 | $V_{DRM} \& V_{RRM} \quad tp=10ms$ $V_{DSM} \& V_{RSM} = V_{DRM} \& V_{RRM} + 200V$ | 125 | 600 | | 1800 | V |
| I_{DRM} I_{RRM} | 断态重复峰值电流 反向重复峰值电流 | $V_{DM} = V_{DRM}$ $V_{RM} = V_{RRM}$ | 125 | | | 20 | mA |
| I_{TSM} | 通态不重复浪涌电流 | 10ms 正弦半波 | 125 | | | 5.40 | KA |
| I^2t | 浪涌电流平方时间积 | $V_R = 0.6V_{RRM}$ | | | | 146 | $A^2s \times 10^3$ |
| V_{TO} | 门槛电压 | | 125 | | | 0.8 | V |
| r_T | 斜率电阻 | | 125 | | | 1.69 | mΩ |
| V_{TM} | 通态峰值电压 | $I_{TM} = 480A$ | 25 | | | 1.70 | V |
| dv/dt | 断态电压临界上升率 | $V_{DM} = 67\% V_{DRM}$ | 125 | | | 800 | V/μs |
| di/dt | 通态电流临界上升率 | $I_{TM} = 320A$, 门极触发电流幅值 $I_{GM} = 1.5A$, 门极上升时间 $tr \leq 0.5 \mu s$ | 125 | | | 100 | A/μs |
| I_{GT} | 门极触发电流 | | | 30 | | 150 | mA |
| V_{GT} | 门极触发电压 | $V_A = 12V, I_A = 1A$ | 25 | 1.0 | | 2.5 | V |
| I_H | 维持电流 | | | 20 | | 150 | mA |
| V_{GD} | 门极不触发电压 | At $67\% V_{DRM}$ | 125 | 0.2 | | | V |
| $R_{th(j-c)}$ | 热阻抗(结至壳) | 180° 正弦波, 单面散热 | | | | 0.170 | $^\circ C/W$ |
| $R_{th(c-h)}$ | 热阻抗(壳至散) | 180° 正弦波, 单面散热 | | | | 0.08 | $^\circ C/W$ |
| V_{iso} | 绝缘电压 | 50Hz, R.M.S, t=1min, $I_{iso}: 1mA(MAX)$ | | 2500 | | | V |
| F_m | 安装扭矩(M6) | | | | 6 | | N·m |
| | 安装扭矩(M6) | | | | 6 | | N·m |
| T_{stg} | 贮存温度 | | | -40 | | 125 | $^\circ C$ |
| W_t | 质量 | 外形为301F | | | 320 | | g |
| Size | 包装盒尺寸 | 210 × 113 × 42 (6只装) | | | | | mm |

性能曲线图

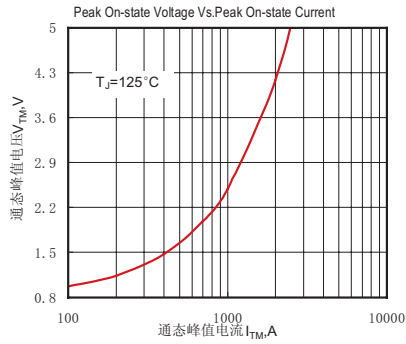

Fig.1 通态伏安特性曲线

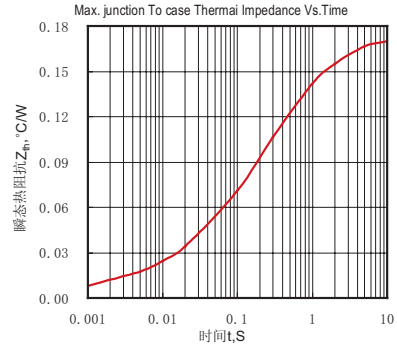

Fig.2 结至管壳瞬态热阻抗曲线

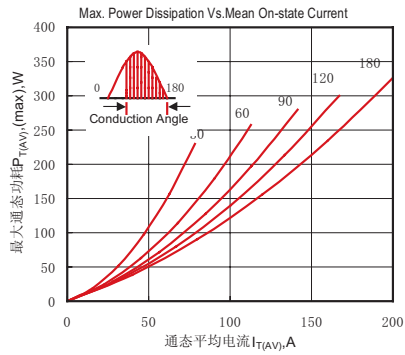

Fig.3 最大功耗与平均电流关系曲线

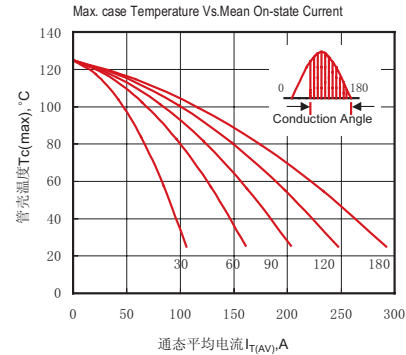

Fig.4 管壳温度与通态平均电流关系曲线

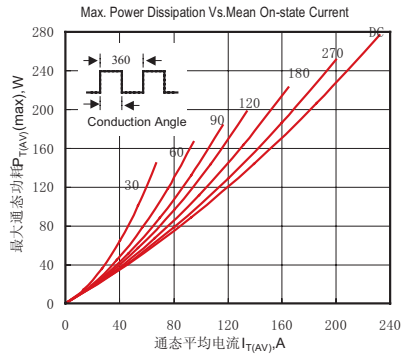

Fig.5 最大功耗与平均电流关系曲线

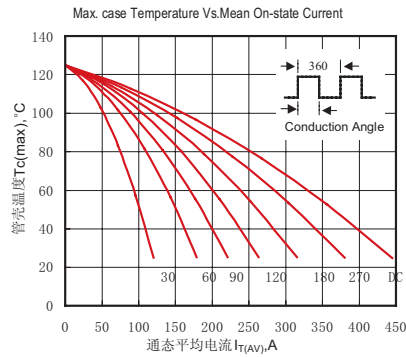

Fig.6 管壳温度与通态平均电流关系曲线

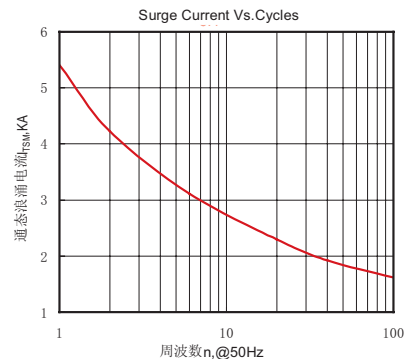

Fig.7 通态浪涌电流与周波数的关系曲线

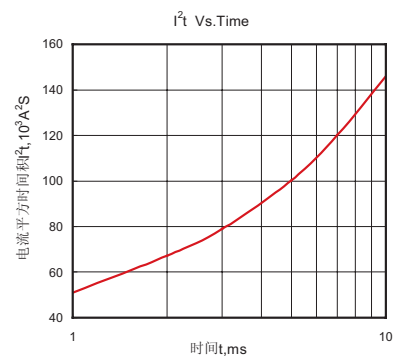

Fig.8 I²t特性曲线

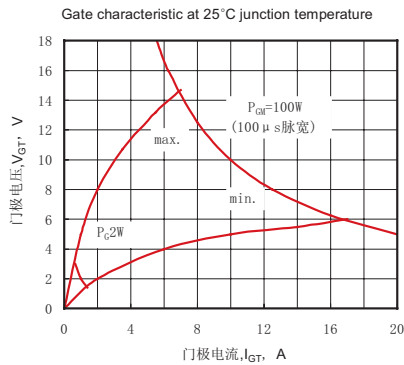

Fig.9 门极功率曲线

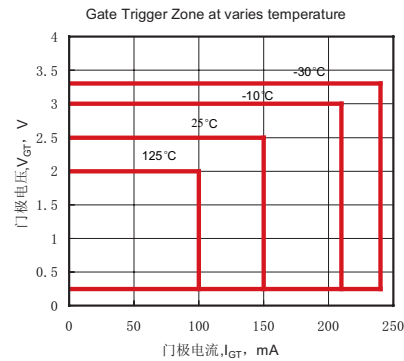
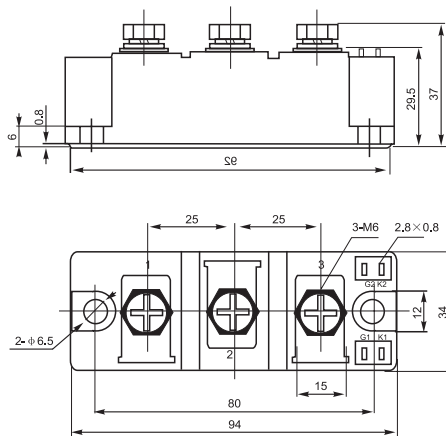
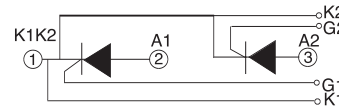

Fig.10 门极触发特性曲线

外形尺寸图



301F



YUEQING LIUJING RECTIFIER CO., LTD
 Sale Department: Liujing Building, Yueqing City, Zhejiang Province
 Add: Wanao Industrial Zone, Yueqing city, Zhejiang Province
 Tel: 0086-577-62519692 0089-577-62519693
 Fax: 0086-577-62518692
 International Export: 0086-577-62571902
 Technical Support: 0086-15868768965
 After Service: 400-6606-086
<http://www.china-liujing.com>
<http://www.liujingdianqi.cn>
<http://www.cnrectifier.com>
<http://www.cnthyristor.com.cn>
 MSN: thristors@hotmail.com

打造最具竞争力的电力半导体产品

To be the most competitive Power Semiconductor Devices manufactory.

LIUJING reserves the right to change limits, test conditions and dimensions.

윤정은 이 칼타로그 중에 데이트, 테스트 조건, 외형사이즈에 대한 최종 해석권을 가지고 있습니다.