

### 特点

- 1). 芯片与底板电气绝缘, 2500V交流电压
- 2). 全压接结构, 优良的温度特性和功率循环能力
- 3). 体积小,重量轻

### 典型应用

- 1). 交直流电机控制
- 2). 各种整流电源
- 3). 变频器

$I_{F(AV)}$	800A
$V_{RRM}$	600~1800V
$I_{FSM}$	$15 A \times 10^3$
$I^2t$	$1150 A^2S \times 10^3$

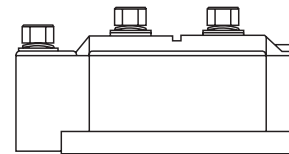

### 主要参数

符号	参数	测试条件	结温	参数值			单位
			$T_j(^{\circ}C)$	最小	典型	最大	
$I_{F(AV)}$	正向平均电流	$180^{\circ}$ 正弦半波, 50Hz, 单面散热, $T_c=100^{\circ}C$	150			800	A
$I_{F(RMS)}$	方均根电流		150			1256	A
$V_{RRM}$	反向重复峰值电压	$V_{RRM}$ tp=10ms, $V_{RSM} = V_{RRM} + 200V$	150	600		1800	V
$I_{RRM}$	反向重复峰值电流	$V_{RM} = V_{RRM}$	150			45	mA
$I_{FSM}$	正向不重复浪涌电流		150			18.0	KA
$I^2t$	浪涌电流平方时间积	10ms底宽, 正弦半波, $V_R = 0.6V_{RRM}$	150			1650	$A^2s \times 10^3$
$V_{FO}$	门槛电压		150			0.75	V
$r_F$	斜率电阻		150			0.33	m $\Omega$
$V_{FM}$	正向峰值电压	$I_{FM} = 2400A$	25			1.80	V
$R_{th(j-c)}$	热阻抗(结至散热器)	$180^{\circ}$ 正弦半波, 单面散热				0.080	$^{\circ}C / W$
$V_{iso}$	绝缘电压	50Hz, R.M.S, t=1min, $I_{iso}: 1mA(max)$		2500			V
$F_m$	安装扭矩(M12)				14		N·m
	安装扭矩(M8)				12		N·m
$T_{stg}$	贮存温度			-40		125	$^{\circ}C$
$W_t$	质量	外形为601F			3500		g
Size	包装盒尺寸	160 × 75 × 80 (1只装)					mm

性能曲线图

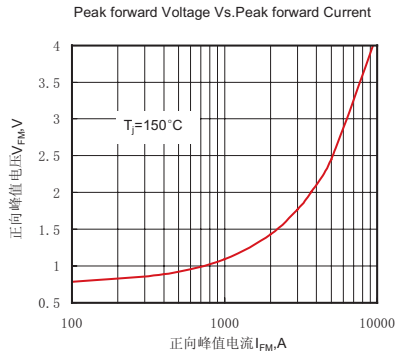

Fig.1 正向伏安特性曲线

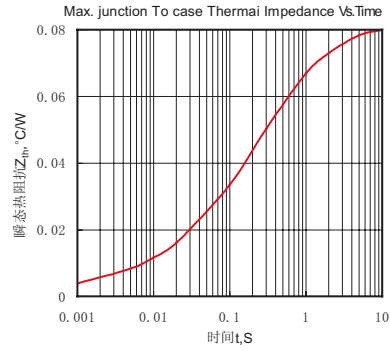

Fig.2 瞬态热阻抗曲线

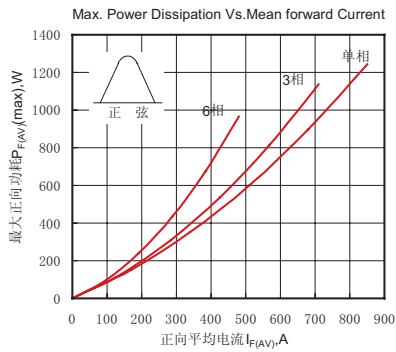

Fig.3最大正向功耗与平均电流的关系曲线

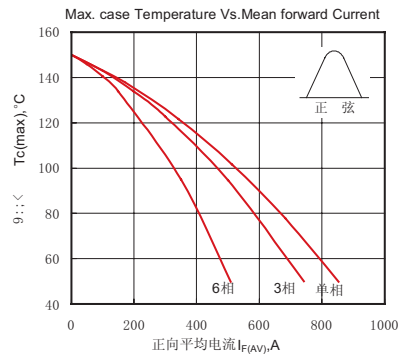

Fig.4管壳温度与正向平均电流的关系曲线

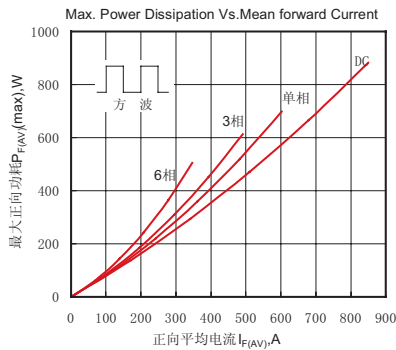

Fig.5最大正向功耗与平均电流的关系曲线

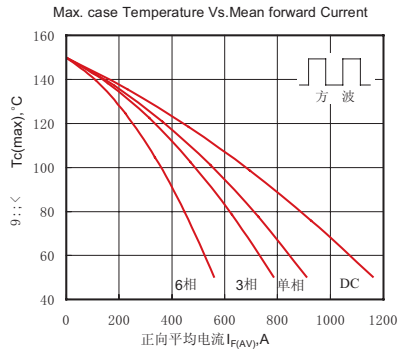

Fig.6管壳温度与正向平均电流的关系曲线

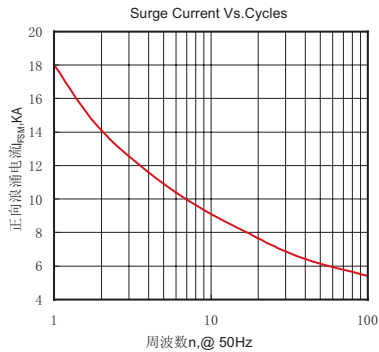

Fig.7 正向浪涌电流与周波数的关系曲线

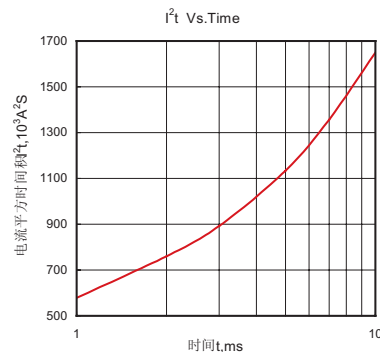
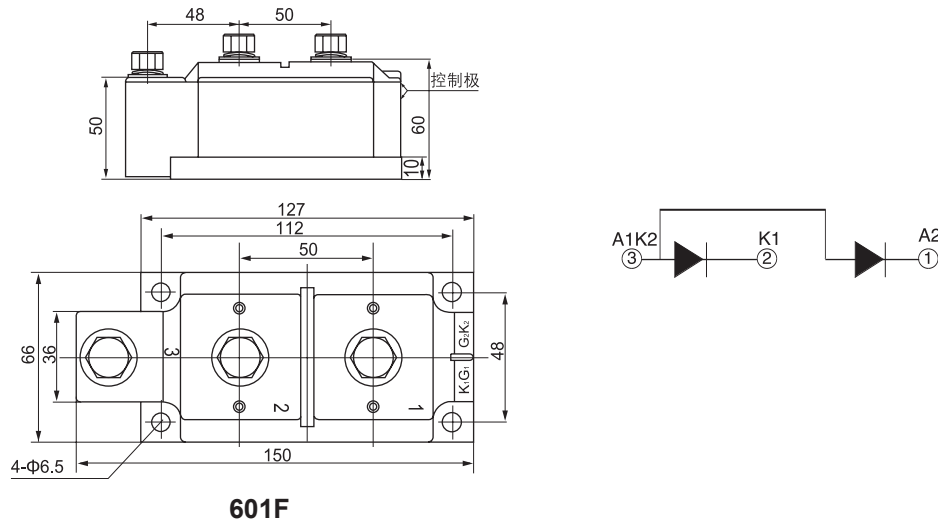

Fig.8 I<sup>2</sup>t特性曲线

外形尺寸图



**YUEQING LIUJING RECTIFIER CO., LTD**

Sale Department: Liujing Building, Yueqing City,  
Zhejiang Province

Add: Wanao Industrial Zone, Yueqing city,  
Zhejiang Province

Tel: 0086-577-62519692    0089-577-62519693

Fax: 0086-577-62518692

International Export: 0086-577-62571902

Technical Support: 0086-15868768965

After Service: 400-6606-086

<http://www.china-liujing.com>

<http://www.liujingdianqi.cn>

<http://www.cnrectifier.com>

<http://www.cnthyristor.com.cn>

MSN: [thristors@hotmail.com](mailto:thristors@hotmail.com)

**打造最具竞争力的电力半导体产品**

To be the most competitive Power Semiconductor  
Devices manufactory.

LIUJING reserves the right to change limits, test conditions and dimensions.

윤정은 이 칼타로그 중에 데이트, 테스트 조건, 외형사이즈에 대한 최종 해석권을 가지고 있습니다.