

### 特点

- 1). 芯片与底板电气绝缘, 2500V交流电压
- 2). 全压接结构, 优良的温度特性和功率循环能力
- 3). 体积小, 重量轻

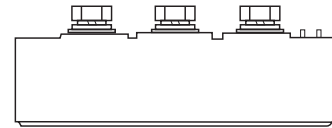

### 典型应用

- |             |             |                        |
|-------------|-------------|------------------------|
| 1). 交直流电机控制 | $I_{F(AV)}$ | 200A                   |
| 2). 各种整流电源  | $V_{RRM}$   | 600~1800V              |
| 3). 变频器     | $I_{FSM}$   | $8 A \times 10^3$      |
|             | $I^2t$      | $326 A^2S \times 10^3$ |

### 主要参数

符号	参数	测试条件	结温	参数值			单位
			$T_j(^\circ C)$	最小	典型	最大	
$I_{F(AV)}$	正向平均电流	180° 正弦半波, 50Hz, 单面散热, $T_c=100^\circ C$	150			200	A
$I_{F(RMS)}$	方均根电流		150			314	A
$V_{RRM}$	反向重复峰值电压	$V_{RRM}$ tp=10ms, $V_{RSM} = V_{RRM} + 200V$	150	600		1800	V
$I_{RRM}$	反向重复峰值电流	$V_{RM} = V_{RRM}$	150			12	mA
$I_{FSM}$	正向不重复浪涌电流		150			8.00	KA
$I^2t$	浪涌电流平方时间积	10ms底宽, 正弦半波, $V_R = 0.6V_{RRM}$	150			326	$A^2s \times 10^3$
$V_{FO}$	门槛电压		150			0.75	V
$r_F$	斜率电阻		150			0.88	mΩ
$V_{FM}$	正向峰值电压	$I_{FM} = 600A$	25			1.38	V
$R_{th(j-c)}$	热阻抗(结至散热器)	180° 正弦半波, 单面散热				0.210	$^\circ C / W$
$R_{th(c-h)}$	热阻抗(壳至散)	180° 正弦半波, 单面散热				0.08	$^\circ C / W$
$V_{iso}$	绝缘电压	50Hz, R.M.S, t=1min, $I_{iso}: 1mA(max)$		2500			V
$F_m$	安装扭矩(M6)				6		N·m
	安装扭矩(M6)				6		N·m
$T_{stg}$	贮存温度			-40		125	$^\circ C$
$W_t$	质量	外形为301F、401F			320		g
Size	包装盒尺寸	210 × 113 × 42 (6只装)、120 × 67 × 56 (1只装)					mm

性能曲线图

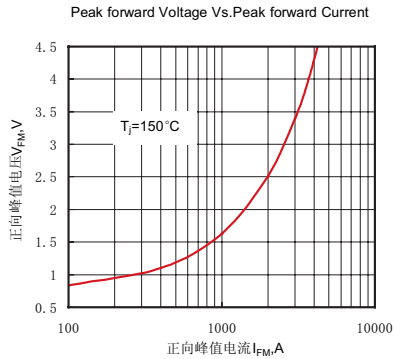

Fig.1 正向伏安特性曲线

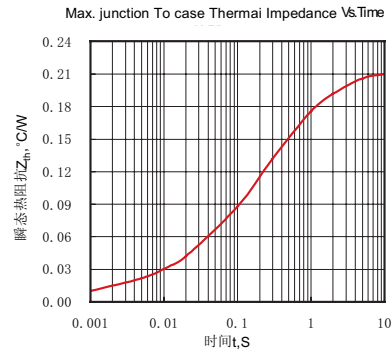

Fig.2 瞬态热阻抗曲线

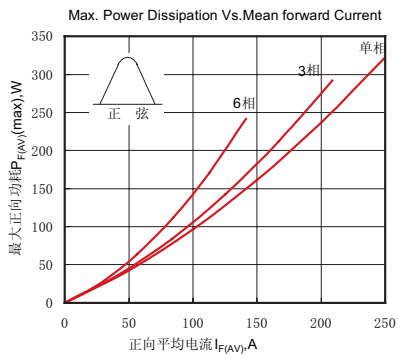

Fig.3 最大正向功耗与平均电流的关系曲线

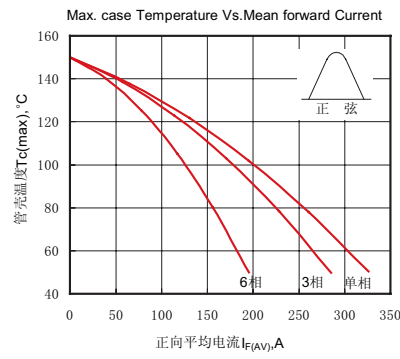

Fig.4 管壳温度与正向平均电流的关系曲线

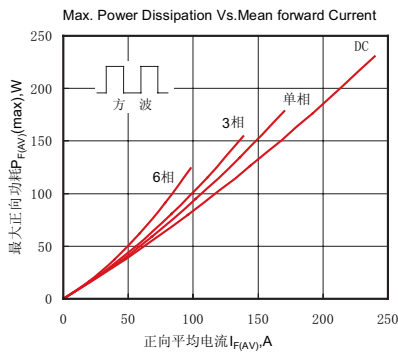

Fig.5 最大正向功耗与平均电流的关系曲线

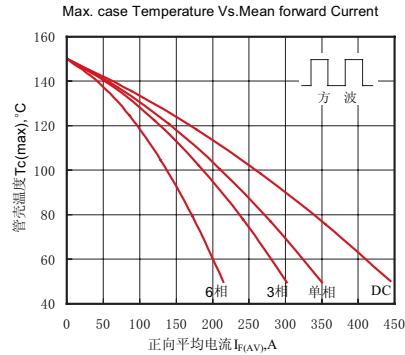

Fig.6 管壳温度与正向平均电流的关系曲线

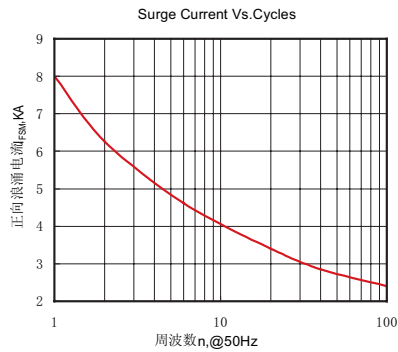

Fig.7 正向浪涌电流与周波数的关系曲线

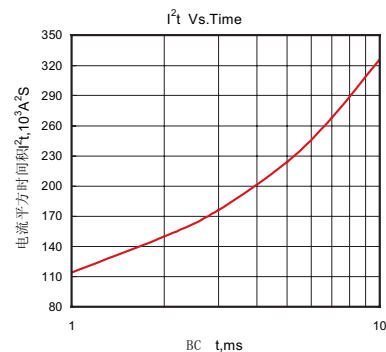
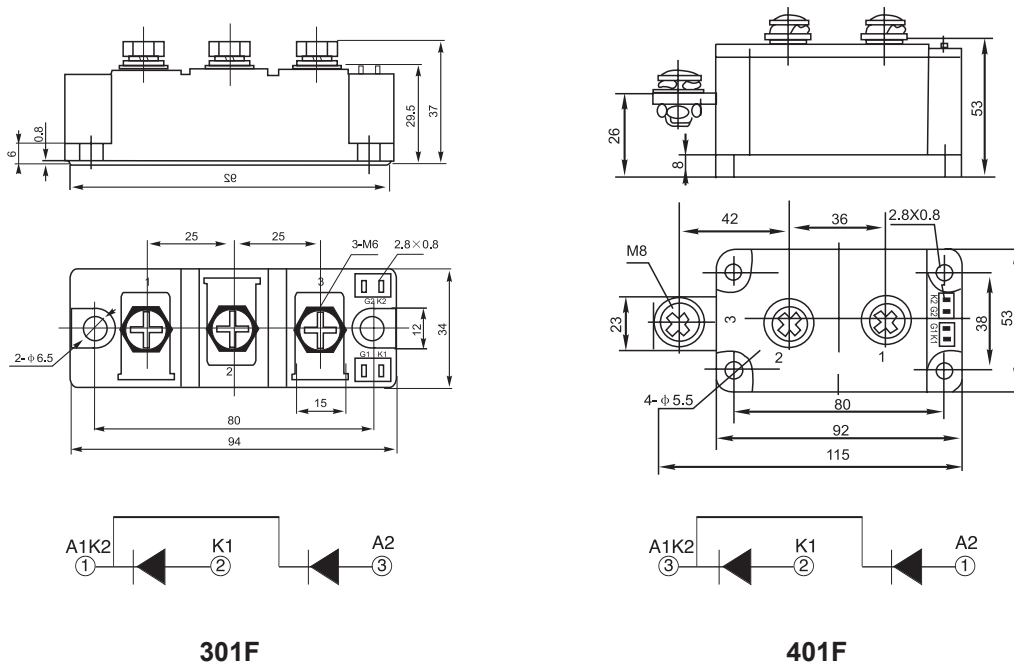

Fig.8 I<sup>2</sup>t特性曲线

外形尺寸图



**YUEQING LIUJING RECTIFIER CO., LTD**  
 Sale Department: Liuqing Building, Yueqing City,  
 Zhejiang Province  
 Add: Wanao Industrial Zone, Yueqing city,  
 Zhejiang Province  
 Tel: 0086-577-62519692    0089-577-62519693  
 Fax: 0086-577-62518692  
 International Export: 0086-577-62571902  
 Technical Support: 0086-15868768965  
 After Service: 400-6606-086  
<http://www.china-liujing.com>  
<http://www.liujingdianqi.cn>  
<http://www.cnrectifier.com>  
<http://www.cnthyristor.com.cn>  
 MSN: thristors@hotmail.com

**打造最具竞争力的电力半导体产品**  
 To be the most competitive Power Semiconductor  
 Devices manufactory.

LIUJING reserves the right to change limits, test conditions and dimensions.  
 윤정은 이 칼타로그 중에 데이터, 테스트 조건, 외형사이즈에 대한 최종 해석권을 가지고 있습니다.