

特点

- 1). 芯片与底板电气绝缘, 2500V交流电压
- 2). 全压接结构, 优良的温度特性和功率循环能力
- 3). 体积小, 重量轻

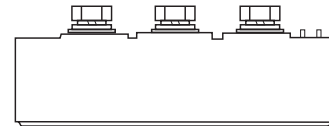

典型应用

- | | | |
|-------------|-------------|------------------------|
| 1). 交直流电机控制 | $I_{F(AV)}$ | 200A |
| 2). 各种整流电源 | V_{RRM} | 600~1800V |
| 3). 变频器 | I_{FSM} | $8 A \times 10^3$ |
| | I^2t | $326 A^2S \times 10^3$ |

主要参数

符号	参数	测试条件	结温	参数值			单位
			$T_j(°C)$	最小	典型	最大	
$I_{F(AV)}$	正向平均电流	180° 正弦半波, 50Hz, 单面散热, $T_c=100°C$	150			200	A
$I_{F(RMS)}$	方均根电流		150			314	A
V_{RRM}	反向重复峰值电压	V_{RRM} tp=10ms, $V_{RSM} = V_{RRM} + 200V$	150	600		1800	V
I_{RRM}	反向重复峰值电流	$V_{RM} = V_{RRM}$	150			12	mA
I_{FSM}	正向不重复浪涌电流		150			8.00	KA
I^2t	浪涌电流平方时间积	10ms底宽, 正弦半波, $V_R = 0.6V_{RRM}$	150			326	$A^2s \times 10^3$
V_{FO}	门槛电压		150			0.75	V
r_F	斜率电阻					0.88	mΩ
V_{FM}	正向峰值电压	$I_{FM} = 600A$	25			1.38	V
$R_{th(j-c)}$	热阻抗(结至散热器)	180° 正弦半波, 单面散热				0.210	°C /W
$R_{th(c-h)}$	热阻抗(壳至散)	180° 正弦半波, 单面散热				0.08	°C /W
V_{iso}	绝缘电压	50Hz, R.M.S, t=1min, $I_{iso}: 1mA(max)$		2500			V
F_m	安装扭矩(M6)				6		N·m
	安装扭矩(M6)				6		N·m
T_{stg}	贮存温度			-40		125	°C
W_t	质量	外形为301F、401F			320		g
Size	包装盒尺寸	210 × 113 × 42 (6只装)、120 × 67 × 56 (1只装)					mm

性能曲线图

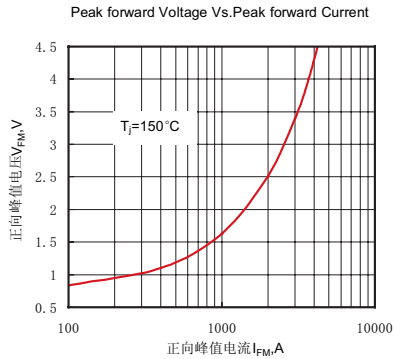

Fig.1 正向伏安特性曲线

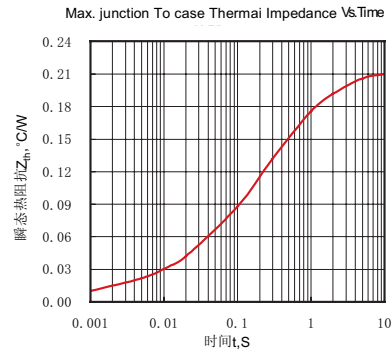

Fig.2 瞬态热阻抗曲线

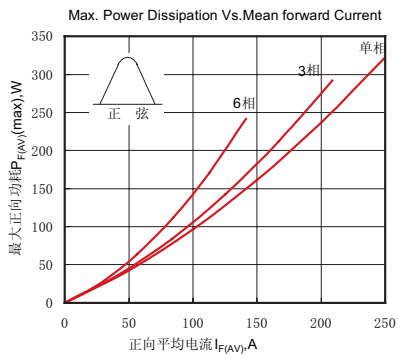

Fig.3 最大正向功耗与平均电流的关系曲线

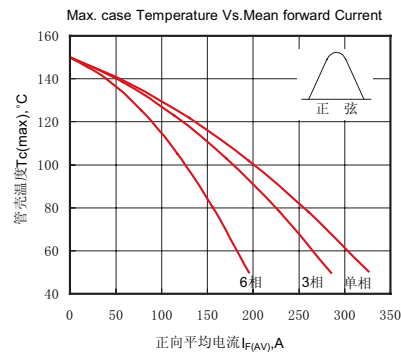

Fig.4 管壳温度与正向平均电流的关系曲线

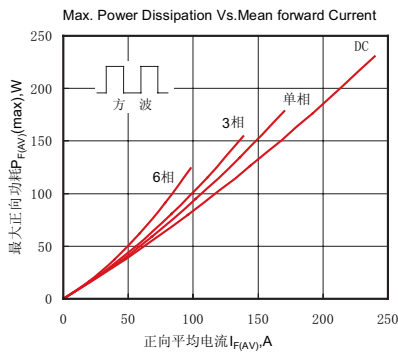

Fig.5 最大正向功耗与平均电流的关系曲线

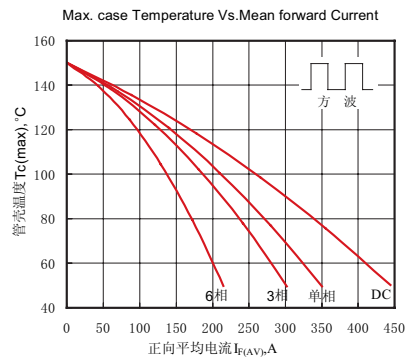

Fig.6 管壳温度与正向平均电流的关系曲线

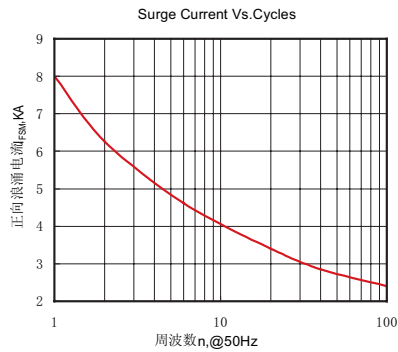

Fig.7 正向浪涌电流与周波数的关系曲线

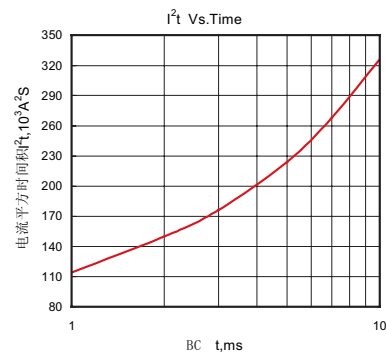
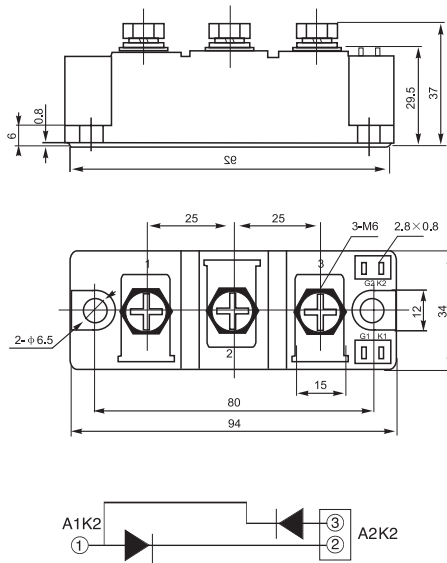
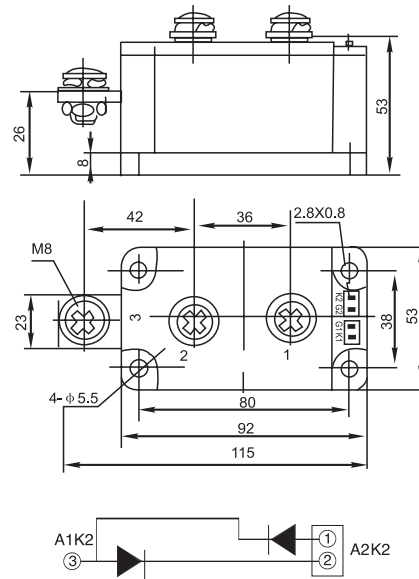

Fig.8 I²t特性曲线

外形尺寸图



301F



401F

YUEQING LIUJING RECTIFIER CO., LTD

Sale Department: Liujiing Building, Yueqing City, Zhejiang Province

Add: Wanao Industrial Zone, Yueqing city, Zhejiang Province

Tel: 0086-577-62519692 0089-577-62519693

Fax: 0086-577-62518692

International Export: 0086-577-62571902

Technical Support: 0086-15868768965

After Service: 400-6606-086

<http://www.china-liujiing.com>

<http://www.liujiingdianqi.cn>

<http://www.cnrectifier.com>

<http://www.cnthyristor.com.cn>

MSN: thristors@hotmail.com

打造最具竞争力的电力半导体产品

To be the most competitive Power Semiconductor Devices manufactory.

LIUJING reserves the right to change limits, test conditions and dimensions.

윤정은 이 칼타로그 중에 데이터, 테스트 조건, 외형사이즈에 대한 최종 해석권을 가지고 있습니다.