

### 特点

- 1). 非绝缘，底板为公共电极
- 2). 全压接结构，优良的温度特性和功率循环能力
- 3). 低正向压降

### 典型应用

- |            |             |                        |
|------------|-------------|------------------------|
| 1). 电焊机电源  | $I_{F(AV)}$ | 300A                   |
| 2). 各种DC电源 | $V_{RRM}$   | 800~1800V              |
| 3). 变频器    | $I_{FSM}$   | $11.5 A \times 10^3$   |
|            | $I^2t$      | $674 A^2S \times 10^3$ |

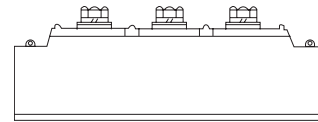

### 主要参数

符号	参数	测试条件	结温	参数值			单位
			$T_j(^\circ\text{C})$	最小	典型	最大	
$I_{F(AV)}$	正向平均电流	$180^\circ$ 正弦半波, 50Hz, 单面散热, $T_c=100^\circ\text{C}$	150			300	A
$I_{F(RMS)}$	方均根电流		150			417	A
$V_{RRM}$	反向重复峰值电压	$V_{RRM}$ tp=10ms, $V_{RSM} = V_{RRM} + 200V$	150	800		1800	V
$I_{RRM}$	反向重复峰值电流	at $V_{RRM}$	150			25	mA
$I_{FSM}$	正向不重复浪涌电流	10ms底宽, 正弦半波, $V_R = 0.6V_{RRM}$	150			11.5	KA
$I^2t$	浪涌电流平方时间积					674	$A^2s \times 10^3$
$V_{FO}$	门槛电压		150			0.80	V
$r_F$	斜率电阻					0.64	m $\Omega$
$V_{FM}$	正向峰值电压	$I_{FM} = 900A$	25			1.50	V
$R_{th(j-c)}$	热阻抗(结至散热器)	单面散热				0.130	$^\circ\text{C}/W$
$R_{th(c-h)}$	热阻抗(壳至散)	单面散热				0.04	$^\circ\text{C}/W$
$F_m$	安装扭矩(M8)				12.0		N·m
	安装扭矩(M6)				6.0		N·m
$T_{stg}$	贮存温度			-40		125	$^\circ\text{C}$
$W_t$	质量	外形为103B			680		g
Size	包装盒尺寸						mm

性能曲线图

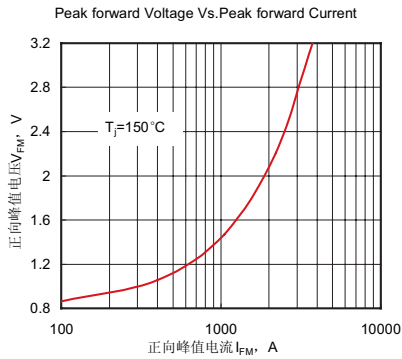

Fig.1 正向伏安特性曲线

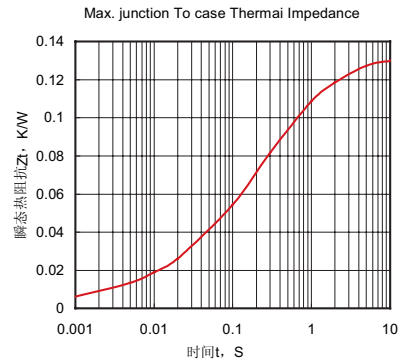

Fig.2 瞬态热阻抗曲线

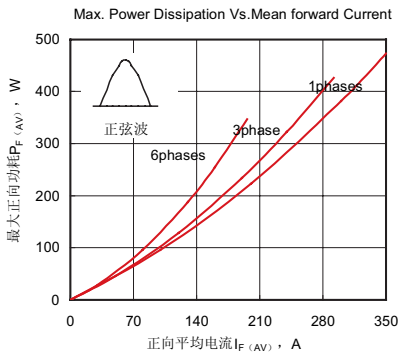

Fig.3最大正向功耗与平均电流的关系曲线

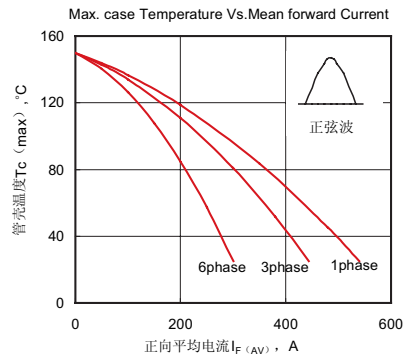

Fig.4管壳温度与正向平均电流的关系曲线

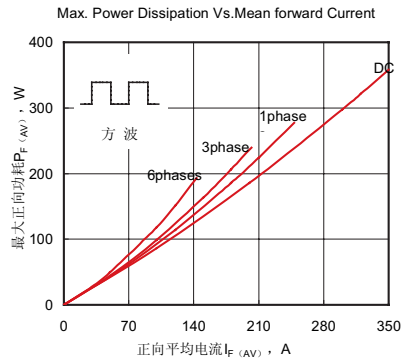

Fig.5最大正向功耗与平均电流的关系曲线

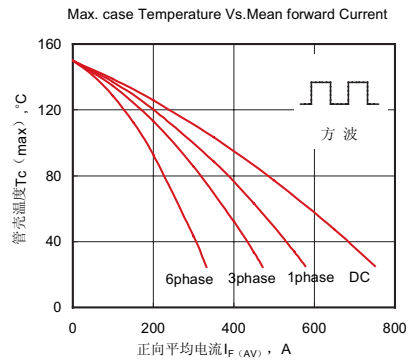

Fig.6管壳温度与正向平均电流的关系曲线

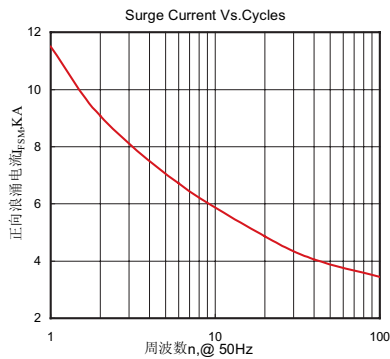

Fig.7 正向浪涌电流与周波数的关系曲线

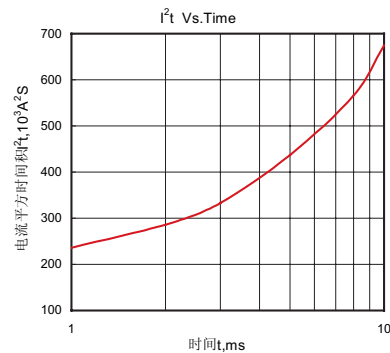
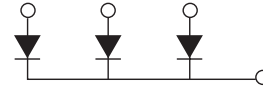
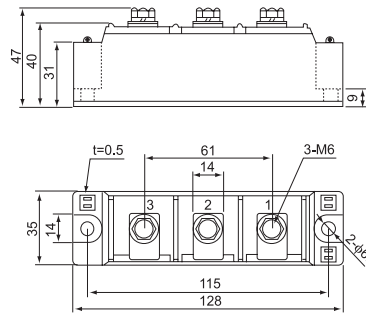

Fig.8 I<sup>2</sup>t特性曲线

外形尺寸图



103B

**YUEQING LIUJING RECTIFIER CO., LTD**

Sale Department: Liujing Building, Yueqing City,  
Zhejiang Province

Add: Wanao Industrial Zone, Yueqing city,  
Zhejiang Province

Tel: 0086-577-62519692    0089-577-62519693

Fax: 0086-577-62518692

International Export: 0086-577-62571902

Technical Support: 0086-15868768965

After Service: 400-6606-086

<http://www.china-liujing.com>

<http://www.liujingdianqi.cn>

<http://www.cnrectifier.com>

<http://www.cnthyristor.com.cn>

MSN: thristors@hotmail.com

**打造最具竞争力的电力半导体产品**

To be the most competitive Power Semiconductor  
Devices manufactory.

LIUJING reserves the right to change limits, test conditions and dimensions.

윤정은 이 칼타로그 중에 데이트, 테스트 조건, 외형사이즈에 대한 최종 해석권을 가지고 있습니다.