

### 特点

- 1). 非绝缘，底板为公共电极
- 2). 全压接结构，优良的温度特性和功率循环能力
- 3). 低正向压降

### 典型应用

- 1). 电焊机电源
- 2). 各种DC电源
- 3). 变频器

$I_{T(AV)}$	200A
$V_{DRM}/V_{RRM}$	800~1800V
$I_{TSM}$	$6.5 A \times 10^3$
$I^2t$	$215 A^2S \times 10^3$

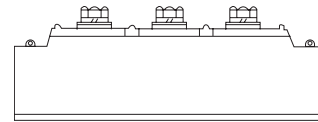

### 主要参数

符号	参数	测试条件	结温	参数值			单位
			$T_j(^\circ C)$	最小	典型	最大	
$I_{T(AV)}$	通态平均电流	180° 正弦半波, 50Hz 单面散热, $T_c=90^\circ C$	125			200	A
$I_{T(RMS)}$	方均根电流		125			314	A
$V_{DRM}$ $V_{RRM}$	断态重复峰值电压 反向重复峰值电压	$V_{DRM} \& V_{RRM}$ tp=10ms $V_{DSM} \& V_{RSM} = V_{DRM} \& V_{RRM} + 200V$	125	800		1800	V
$I_{DRM}$ $I_{RRM}$	断态重复峰值电流 反向重复峰值电流	at $V_{DRM}$ at $V_{RRM}$	125			20	mA
$I_{TSM}$	通态不重复浪涌电流	10ms 正弦半波	125			6.50	KA
$I^2t$	浪涌电流平方时间积	$V_R=60\% V_{RRM}$	125			215	$A^2s \times 10^3$
$V_{TO}$	门槛电压		125			0.80	V
$r_T$	斜率电阻		125			1.15	mΩ
$V_{TM}$	通态峰值电压	$I_{TM}=600A$	25			1.62	V
dv/dt	断态电压临界上升率	$V_{DM}=67\% V_{DRM}$	125			800	V/μs
di/dt	通态电流临界上升率	门极触发电流1.5A, 上升时间 $tr \leq 1 \mu s$	125			100	A/μs
$I_{GT}$	门极触发电流			30		150	mA
$V_{GT}$	门极触发电压	$V_A=12V, I_A=1A$	25	0.8		2.5	V
$I_H$	维持电流			20		200	mA
$V_{GD}$	门极不触发电压	At $67\% V_{DRM}$	125	0.2			V
$R_{th(j-c)}$	热阻抗(结至壳)	单面散热				0.130	$^\circ C / W$
$R_{th(c-h)}$	热阻抗(壳至散)	单面散热				0.1	$^\circ C / W$
$F_m$	安装扭矩(M6)				6		N·m
	安装扭矩(M6)				6		N·m
$T_{slg}$	存储温度			-40		125	$^\circ C$
$W_t$	质量	外形为102B、103B			380		g
Size	包装盒尺寸						mm

性能曲线图

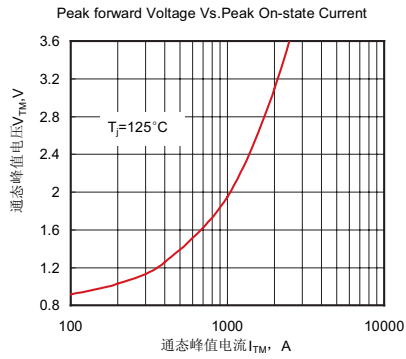

Fig.1通态伏安特性曲线

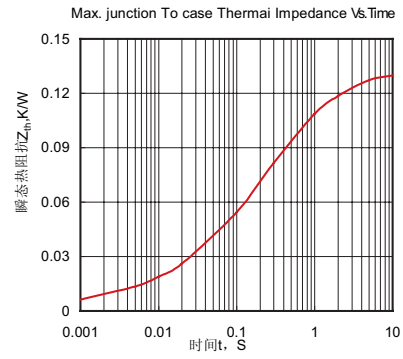

Fig.2 瞬态热阻抗曲线

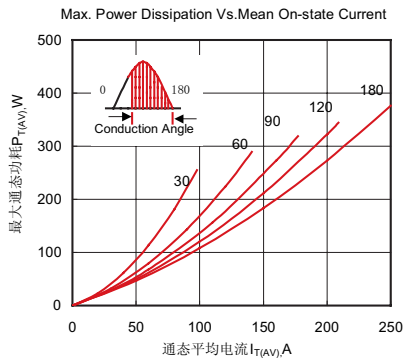

Fig.3最大通态功耗与通态平均电流的关系曲线

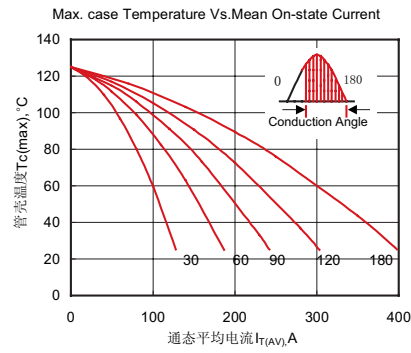

Fig.4 管壳温度与通态平均电流的关系曲线

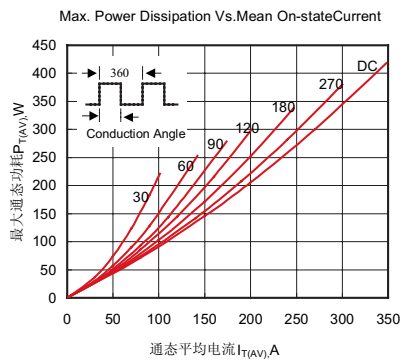

Fig.5最大通态功耗与通态平均电流的关系曲线

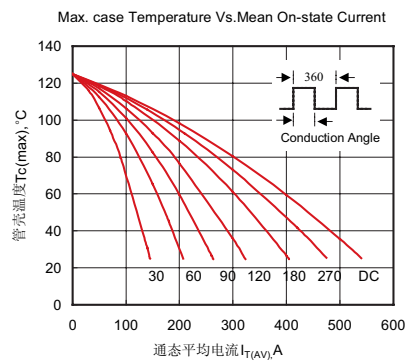

Fig.6管壳温度与通态平均电流的关系曲线

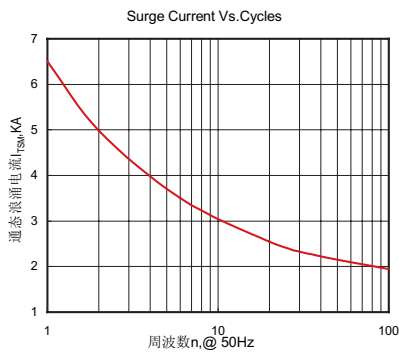

Fig.7 通态浪涌电流与周波数的关系曲线

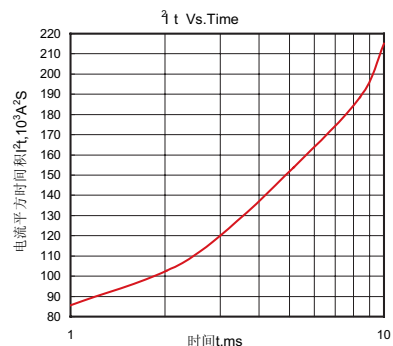

Fig.8  $I^2t$ 特性曲线

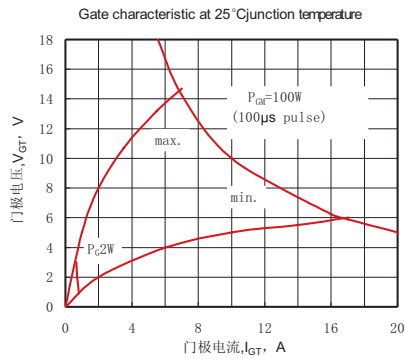

Fig.9 门极功率曲线

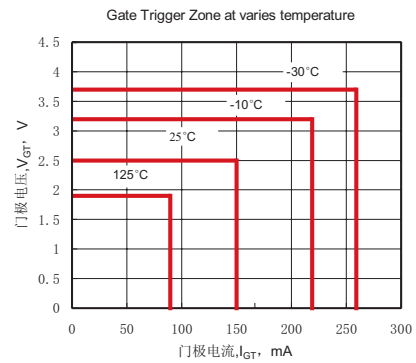
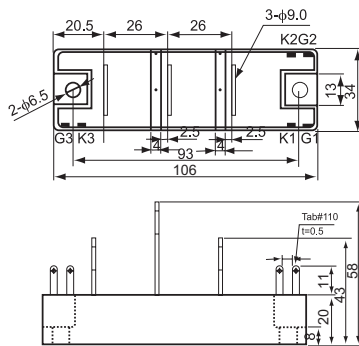
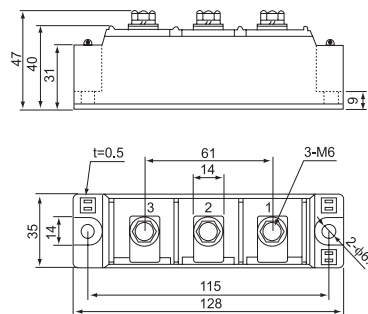

Fig.10 门极触发特性曲线

外形尺寸图



102B



103B

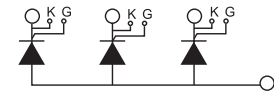

**YUEQING LIUJING RECTIFIER CO., LTD**

Sale Department: Liuqing Building, Yueqing City, Zhejiang Province

Add: Wanao Industrial Zone, Yueqing city, Zhejiang Province

Tel: 0086-577-62519692 0089-577-62519693

Fax: 0086-577-62518692

International Export: 0086-577-62571902

Technical Support: 0086-15868768965

After Service: 400-6606-086

<http://www.china-liuqing.com>

<http://www.liuqingdianqi.cn>

<http://www.cnrectifier.com>

<http://www.cnthyristor.com.cn>

MSN: thristors@hotmail.com

**打造最具竞争力的电力半导体产品**

To be the most competitive Power Semiconductor Devices manufactory.

LIUJING reserves the right to change limits, test conditions and dimensions.

윤정은 이 칼타로그 중에 데이트, 테스트 조건, 외형사이즈에 대한 최종 해석권을 가지고 있습니다.