

FEATURES

- 1). Center amplifying gate
- 2). Metal case with ceramic insulator
- 3). Low on-state and switching losses

TYPICAL APPLICATIONS

- 1). AC controllers
- 2). DC and AC motor control
- 3). Controlled rectifiers

$I_{T(AV)}$ 1583 A
 V_{DRM}/V_{RRM} 5600-6500V
 I_{TSM} 16 KA
 I^2t 1280 10³A²S

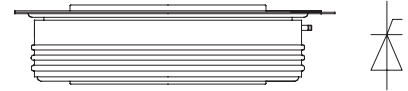

THE MAIN PARAMETERS

SYMBOL	CHARACTERISTIC	TEST CONDITIONS	T _J (°C)	VALUE			UNIT
				Min	Type	Max	
I _{T(AV)}	Mean on-state current	180° half sine wave 50Hz Double side cooled, T _{hs} =55°C T _{hs} =91°C	125			1583 1100	A
V _{DRM} V _{RRM}	Repetitive peak off-state voltage Repetitive peak reverse voltage	V _{DRM} &V _{RRM} , tp=10ms V _{DSM} &V _{RSM} =V _{DRM} &V _{RRM} +100V	125	5600		6500	V
I _{DRM} I _{RRM}	Repetitive peak off-state current Repetitive peak reverse current	V _D =V _{DRM} V _R =V _{RRM}	125			200	mA
I _{TSM}	Surge on-state current	10ms half sine wave	125			16	KA
I ² t	I ² T for fusing coordination	V _R =0.6V _{RRM}	125			1280	A ² s*10 ³
V _{TO}	Threshold voltage		125			1.21	V
r _T	On-state slop resistance		125			0.50	mΩ
V _{TM}	Peak on-state voltage	I _{TM} =1500A, F=32KN	125			2.41	V
dv/dt	Critical rate of rise of off-state voltage	V _{DM} =0.67V _{DRM}	125			2000	V/μs
di/dt	Critical rate of rise of on-state current	V _{DM} =67%V _{DRM} to2000A, Gate pulse t _r ≤0.5μs I _{GM} =1.5A	125			150	A/μs
I _{rm}	Reverse recovery current	I _{TM} =1500A, tp=1000μs, di/dt=-20A/μs, VR=50V	125			170	A
t _{rr}	Reverse recovery time		125			20	μs
Q _{rr}	Recovery charge		125			1700	μC
I _{GT}	Gate trigger current		25	40		300	mA
V _{GT}	Gate trigger voltage	V _A =12V, I _A =1A	25	0.8		3.0	V
I _H	Holding current		125	20		250	mA
V _{GD}	Non-trigger gate voltage	V _{DM} =67%V _{DRM}	125	0.3			V
R _{th(j-h)}	Thermal resistance Junction to heatsink	At 180° sine, double side cooled Clamping force 32KN				0.014	°C /W
F _m	Mounting force			27		34	KN
T _{stg}	Stored temperature			-40		140	°C
W _t	Weight				850		g
Size	Package box size					160 × 145 × 65	mm

PERFORMANCE CURVES FIGURE

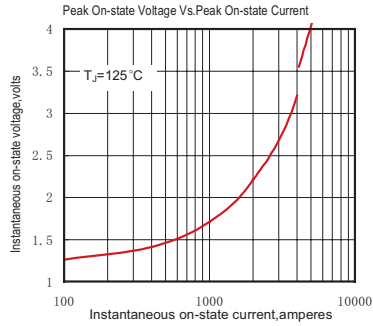

Fig.1

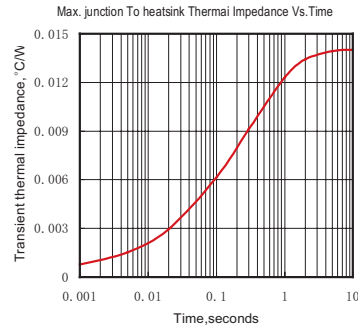

Fig.2

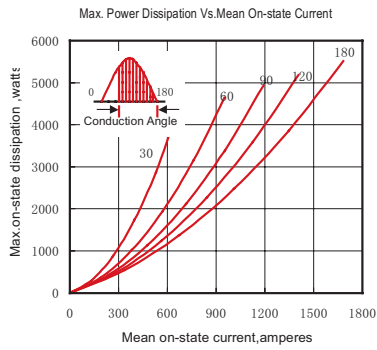

Fig.3

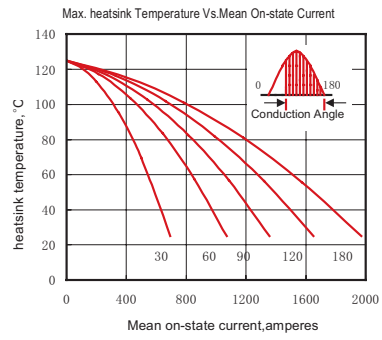

Fig.4

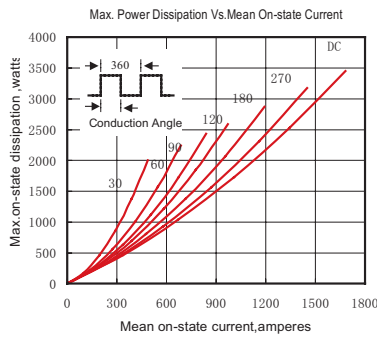

Fig.5

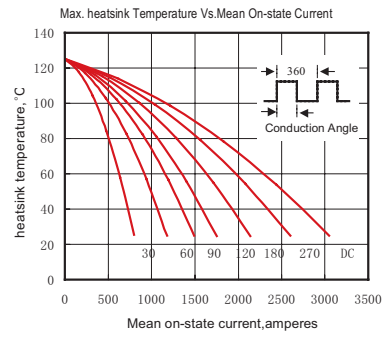

Fig.6

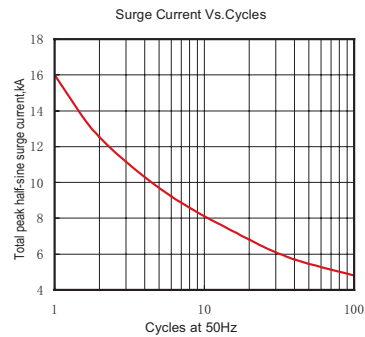

Fig.7

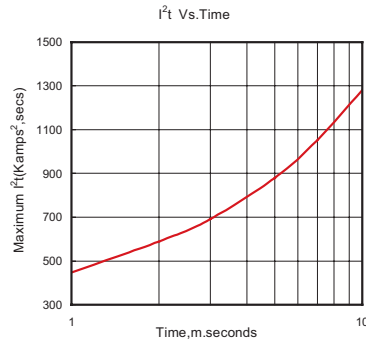

Fig.8

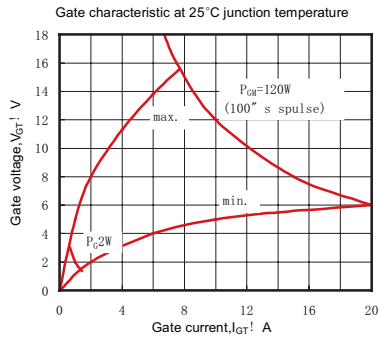

Fig.9

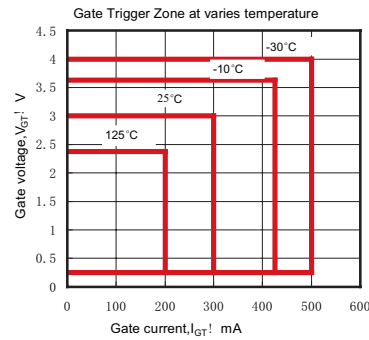
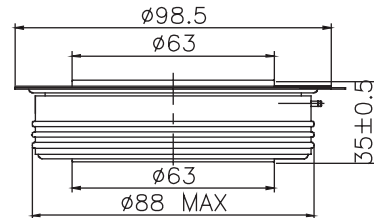
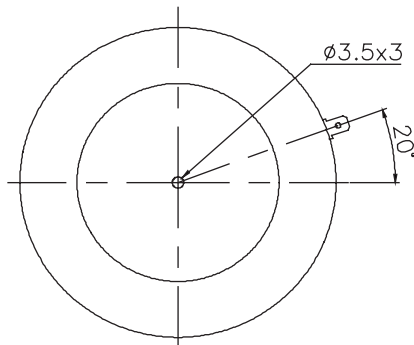

Fig.10

OUTLINE



YUEQING LIUJING RECTIFIER CO., LTD

Sale Department: Liujing Building, Yueqing City, Zhejiang Province

Add: Wanao Industrial Zone, Yueqing city, Zhejiang Province

Tel: 0086-577-62519692 0089-577-62519693

Fax: 0086-577-62518692

International Export: 0086-577-62571902

Technical Support: 0086-15868768965

After Service: 400-6606-086

<http://www.china-liujing.com>

<http://www.liujingdianqi.cn>

<http://www.cnrectifier.com>

<http://www.cnthyristor.com.cn>

MSN: thristors@hotmail.com

打造最具竞争力的电力半导体产品

To be the most competitive Power Semiconductor Devices manufactory.

LIUJING reserves the right to change limits, test conditions and dimensions.

윤정은 이 칼타로그 중에 데이트, 테스트 조건, 외형사이즈에 대한 최종 해석권을 가지고 있습니다.