

### FEATURES

- 1). Center amplifying gate
- 2). Metal case with ceramic insulator
- 3). Low on-state and switching losses

### TYPICAL APPLICATIONS

- 1). AC controllers
- 2). DC and AC motor control
- 3). Controlled rectifiers

$I_{T(AV)}$	376A
$V_{DRM}/V_{RRM}$	1100~1800V
$I_{TSM}$	4.65 KA
$I^2t$	108 $10^3 A^2S$

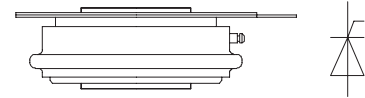

### THE MAIN PARAMETERS

SYMBOL	CHARACTERISTIC	TEST CONDITIONS	$T_j(^{\circ}C)$	VALUE			UNIT
				Min	Type	Max	
$I_{T(AV)}$	Mean on-state current	180° half sine wave 50Hz Double side cooled, $T_{hs}=55^{\circ}C$ $T_{hs}=97^{\circ}C$	125			376 200	A
$V_{DRM}$ $V_{RRM}$	Repetitive peak off-state voltage Repetitive peak reverse voltage	$V_{DRM} \& V_{RRM}, tp=10ms$ $V_{DSM} \& V_{RSM} = V_{DRM} \& V_{RRM} + 100V$	125	1100		1800	V
$I_{DRM}$ $I_{RRM}$	Repetitive peak off-state current Repetitive peak reverse current	$V_D = V_{DRM}$ $V_R = V_{RRM}$	125			16	mA
$I_{TSM}$	Surge on-state current	10ms half sine wave	125			4.65	KA
$I^2t$	$I^2T$ for fusing coordination	$V_R = 0.6V_{RRM}$				108	$A^2s \cdot 10^3$
$V_{TO}$	Threshold voltage		125			0.85	V
$r_T$	On-state slop resistance		125			1.20	$m\Omega$
$V_{TM}$	Peak on-state voltage	$I_{TM}=770A, F=5.0KN$	125			1.77	V
dv/dt	Critical rate of rise of off-state voltage	$V_{DM}=0.67V_{DRM}$	125			1000	$V/\mu s$
di/dt	Critical rate of rise of on-state current	$V_{DM}=67\%V_{DRM}$ to 600A, Gate pulse $t_r \leq 0.5 \mu s, I_{GM}=1.5A$	125			500	$A/\mu s$
$I_{rm}$	Reverse recovery current	$I_{TM}=300A, tp=1000 \mu s,$ $di/dt=-20A/\mu s,$ $VR=50V$	125			100	A
$t_{rr}$	Reverse recovery time					12	$\mu s$
$Q_{rr}$	Recovery charge					600	$\mu C$
$I_{GT}$	Gate trigger current	$V_A=12V, I_A=1A$	25	30		200	mA
$V_{GT}$	Gate trigger voltage			0.8		2.0	V
$I_H$	Holding current	$V_{DM}=0.67V_{DRM}$	125	20		150	mA
$V_{GD}$	Non-trigger gate voltage			0.3			V
$R_{th(j-h)}$	Thermal resistance Junction to heatsink	At 180° sine, double side cooled Clamping force 5.0KN				0.095	$^{\circ}C/W$
$F_m$	Mounting force			3.3		5.5	KN
$T_{stg}$	Stored temperature			-40		140	$^{\circ}C$
$W_t$	Weight				55		g
Size	Package box size			95 × 95 × 50			mm

**PERFORMANCE CURVES FIGURE**

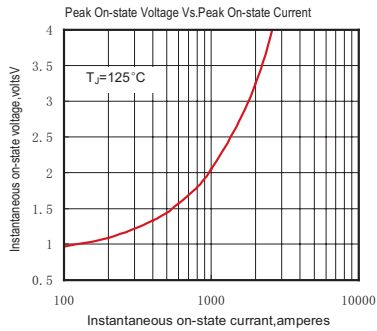

Fig.1

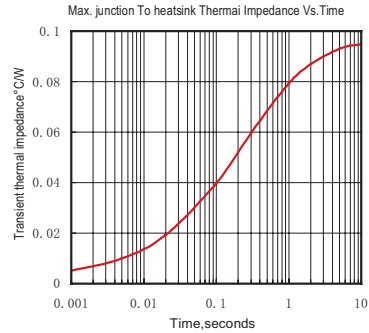

Fig.2

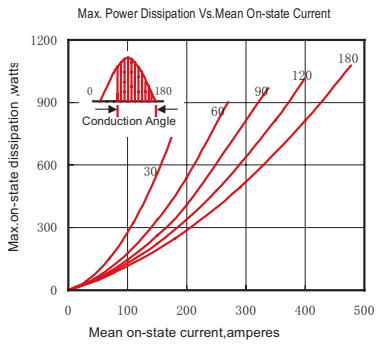

Fig.3

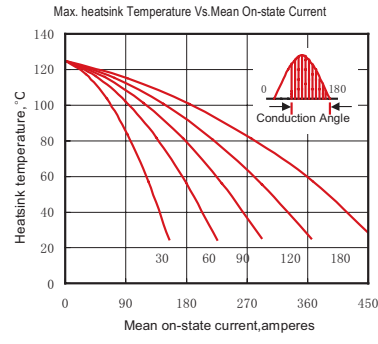

Fig.4

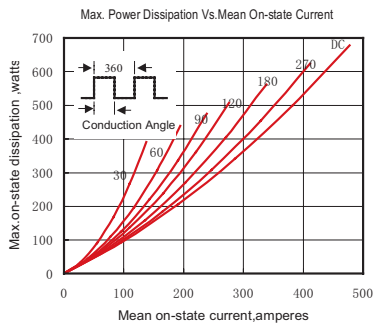

Fig.5

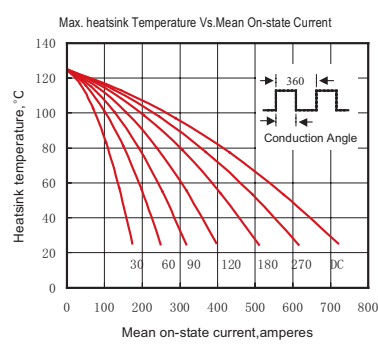

Fig.6

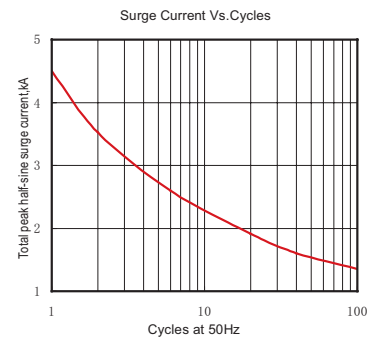

Fig.7

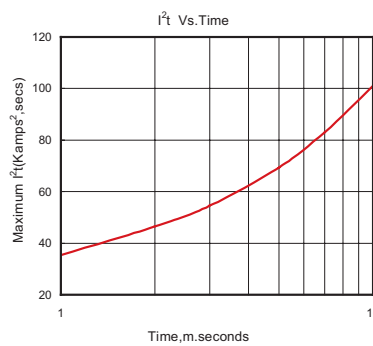

Fig.8

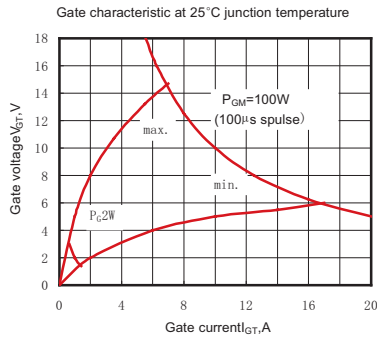

Fig.9

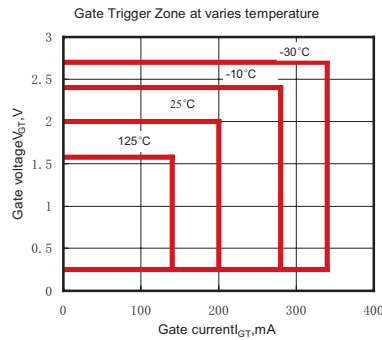
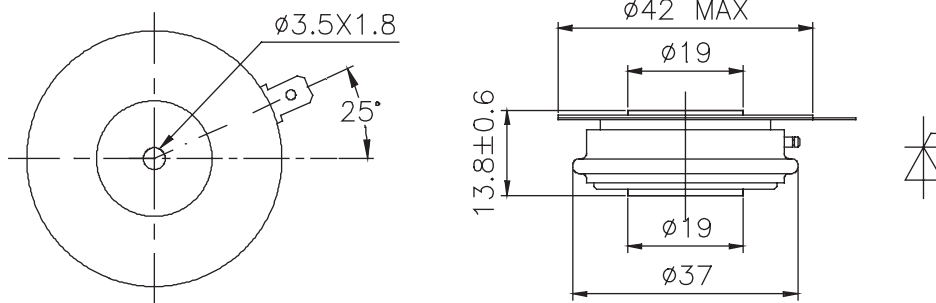

Fig.10

## OUTLINE



### YUEQING LIUJING RECTIFIER CO., LTD

Sale Department: Liujing Building, Yueqing City, Zhejiang Province

Add: Wanao Industrial Zone, Yueqing city, Zhejiang Province

Tel: 0086-577-62519692    0089-577-62519693

Fax: 0086-577-62518692

International Export: 0086-577-62571902

Technical Support: 0086-15868768965

After Service: 400-6606-086

<http://www.china-liujing.com>

<http://www.liujingdianqi.cn>

<http://www.cnrectifier.com>

<http://www.cnthyristor.com.cn>

MSN: [thristors@hotmail.com](mailto:thristors@hotmail.com)

**打造最具竞争力的电力半导体产品**

To be the most competitive Power Semiconductor Devices manufactory.

LIUJING reserves the right to change limits, test conditions and dimensions.

윤정은 이 칼타로그 중에 데이트, 테스트 조건, 외형사이즈에 대한 최종 해석권을 가지고 있습니다.