

特点

- 1). 中心放大门极结构
- 2). 平板型陶瓷管壳封装
- 3). 低通态和开关损耗

典型应用

- 1). 逆变器
- 2). 斩波器
- 3). 感应加热

$I_{T(AV)}$	400 A
V_{DRM}/V_{RRM}	1100-1800V
t_q	5.0 KA
I_{TSM}	125KA

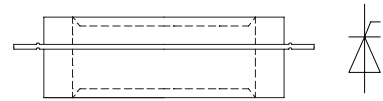

主要参数

符号	参数	测试条件	结温 $T_j(°C)$	参数值			单位
				最小	典型	最大	
$I_{T(AV)}$	通态平均电流	180° 正弦半波, 50Hz 双面散热, $T_{hs}=98°C$ 180° 正弦半波, 50Hz 双面散热, $T_{hs}=55°C$	125			400 852	A
V_{DRM} V_{RRM}	断态重复峰值电压 反向重复峰值电压	$V_{DRM} \& V_{RRM}, tp=10ms$ $V_{DSM} \& V_{RSM} = V_{DRM} \& V_{RRM} + 100V$	125	1100		1800	V
I_{DRM} I_{RRM}	断态重复峰值电流 反向重复峰值电流	$V_D = V_{DRM}$ $V_R = V_{RRM}$	125			40	mA
I_{TSM}	通态不重复浪涌电流	10ms 底宽正弦半波	125			5.0	KA
I^2t	浪涌电流平方时间积	$V_R = 0.6V_{RRM}$				125	$A^2s \cdot 10^3$
V_{TO}	门槛电压		125			0.92	V
r_T	斜率电阻					0.75	$m\Omega$
V_{TM}	通态峰值电压	$I_{TM}=1200A, F=15KN$	25			2.40	V
dv/dt	断态电压临界上升率	$V_{DM}=67\%V_{DRM}$	125			300	$V/\mu s$
di/dt	通态电流临界上升率	$V_{DM}=67\%V_{DRM}$ to 1000A, 门极脉冲 $t_s \leq 0.5 \mu s, I_{GM} = 1.5A$ 重复值	125			100	$A/\mu s$
I_m	反向恢复电流	$I_{TM}=500A, tp=1000 \mu s,$ $di/dt=-20A/\mu s,$ $V_R=50V$	125			140	A
t_{rr}	反向恢复时间					15	μs
Q_{rr}	恢复电荷					1050	μC
I_{GT}	门极触发电流			35		250	mA
V_{GT}	门极触发电压	$V_A=12V, I_A=1A$	25	0.8		2.5	V
I_H	维持电流			20		200	mA
V_{GD}	门极不触发电压	$V_{DM}=67\%V_{DRM}$	125	0.3			V
$R_{th(j-h)}$	热阻抗(结至散热器)	180° 正弦波, 双面散热; 压紧力 15KN				0.040	$°C/W$
F_m	安装力			10		20	KN
T_{stg}	存储温度			-40		140	$°C$
W_t	质量				270		g
Size	包装盒尺寸		95 × 95 × 50				mm

性能曲线图

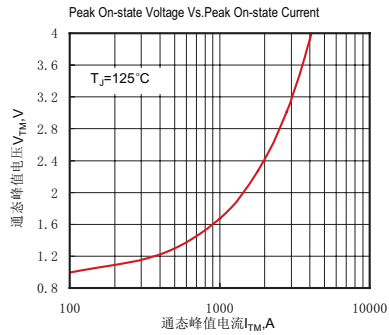

Fig.1 通态伏安特性曲线

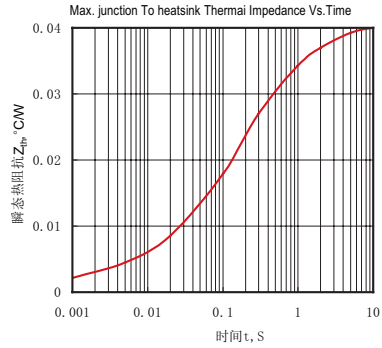

Fig.2 结至散热器瞬态热阻抗曲线

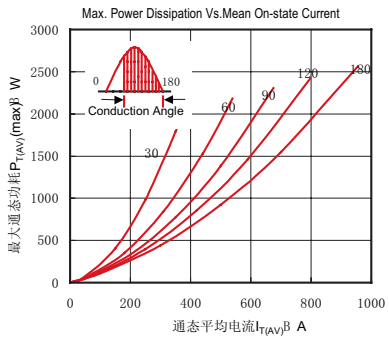

Fig.3 最大功耗与平均电流关系曲线

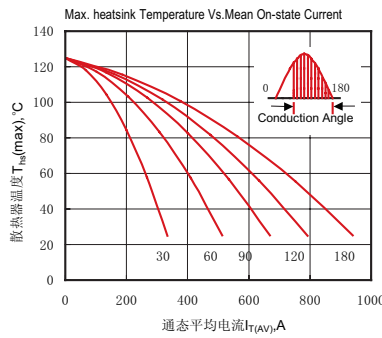

Fig.4 散热器温度与通态平均电流关系曲线

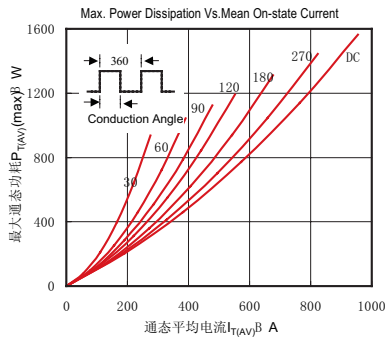

Fig.5 最大功耗与平均电流关系曲线

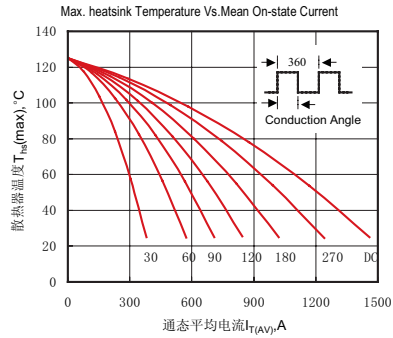

Fig.6 散热器温度与通态平均电流关系曲线

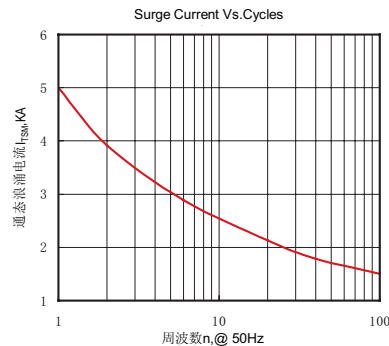

Fig.7 通态浪涌电流与周波数的关系曲线

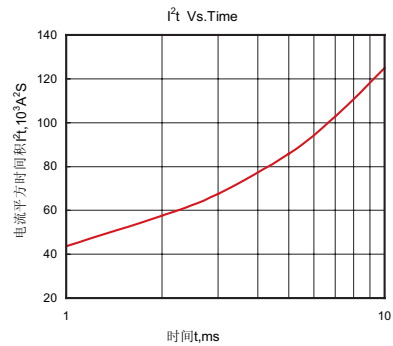

Fig.8 I²t特性曲线

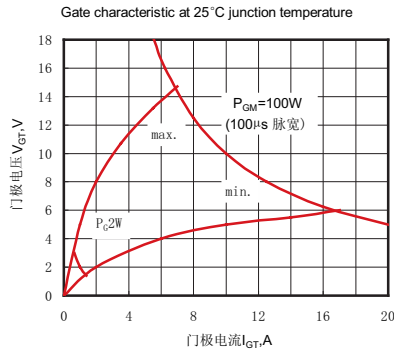

Fig.9 门极功率曲线

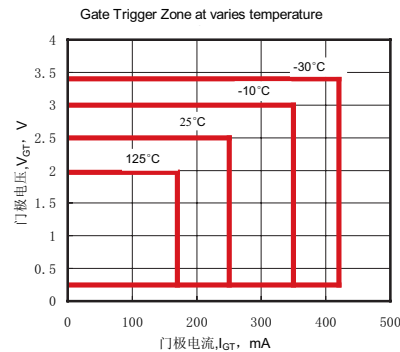
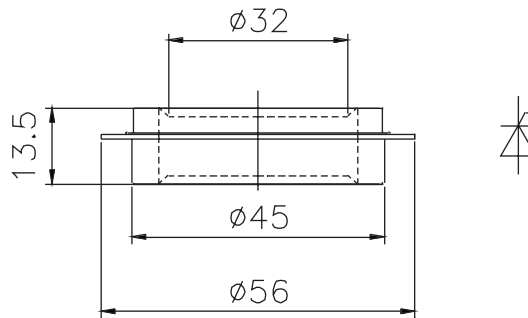

Fig.10 门极触发特性曲线

外形尺寸图



YUEQING LIUJING RECTIFIER CO., LTD

Sale Department: Liujing Building, Yueqing City, Zhejiang Province

Add: Wanao Industrial Zone, Yueqing city, Zhejiang Province

Tel: 0086-577-62519692 0089-577-62519693

Fax: 0086-577-62518692

International Export: 0086-577-62571902

Technical Support: 0086-15868768965

After Service: 400-6606-086

<http://www.china-liujing.com>

<http://www.liujingdianqi.cn>

<http://www.cnrectifier.com>

<http://www.cnthyristor.com.cn>

MSN: thristors@hotmail.com

打造最具竞争力的电力半导体产品

To be the most competitive Power Semiconductor Devices manufactory.

LIUJING reserves the right to change limits, test conditions and dimensions.

윤정은 이 칼타로그 중에 데이터, 테스트 조건, 외형사이즈에 대한 최종 해석권을 가지고 있습니다.