

### FEATURES

- 1). Interdigitated amplifying gates
- 2). Fast turn-on and high di/dt
- 3). Low switching losses

$I_{T(AV)}$	740A
$V_{DRM}/V_{RRM}$	800~1600V
$t_q$	24~50 $\mu$ s
$I_{TSM}$	8.5KA
$I^2t$	361 $10^3 A^2s$

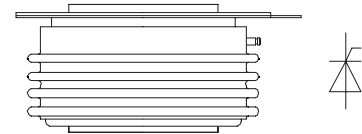

### TYPICAL APPLICATIONS

- 1). Inductive heating
- 2). Electronic welders
- 3). Self-commutated inverters

### THE MAIN PARAMETERS

SYMBOL	CHARACTERISTIC	TEST CONDITIONS	$T_J(^{\circ}C)$	VALUE			UNIT
				Min	Type	Max	
$I_{T(AV)}$	Mean forward current	180° half sine wave 50Hz Double side cooled, $T_{hs}=55^{\circ}C$	125			740	A
$V_{DRM}$ $V_{RRM}$	Repetitive peak off-state voltage Repetitive peak reverse voltage	$V_{DRM} \& V_{RRM}, t_p=10ms$ $V_{DSM} \& V_{RSM} = V_{DRM} \& V_{RRM} + 100V$	125	800		1600	V
$I_{DRM}$ $I_{RRM}$	Repetitive peak off-state current Repetitive peak reverse current	$V_D = V_{DRM}$ $V_R = V_{RRM}$	125			40	mA
$I_{TSM}$ $I^2t$	Surge on-state current $I^2T$ for fusing coordination	10ms half sine wave $V_R=0.6V_{RRM}$	125			8.5 361	KA $A^2s \cdot 10^3$
$V_{TO}$	Threshold voltage		125			1.50	V
$r_T$	On-state slop resistance		125			0.66	m $\Omega$
$V_{TM}$	Peak on-state voltage	$I_{TM}=1400A, F=15KN$	125			2.42	V
dv/dt	Critical rate of rise of off-state voltage	$V_{DM}=0.67V_{DRM}$	125			500	V/ $\mu$ s
di/dt	Critical rate of rise of on-state current	$V_{DM}=67\%V_{DRM}$ to 1000A, Gate pulse $t_r \leq 0.5 \mu$ s $I_{GM}=1.5A$	125			1200	A/ $\mu$ s
$I_m$	Reverse recovery current	$I_{TM}=700A, t_p=1000 \mu$ s, di/dt=-20A/ $\mu$ s, VR=50V	125			49	A
$t_{rr}$	Reverse recovery time					3.4	$\mu$ s
$Q_{rr}$	Recovery charge					83	100
$t_q$	Circuit commutated turn-off time	$I_{TM}=700A, t_p=1000 \mu$ s, $V_R=50V$ dv/dt=30V/ $\mu$ s , di/dt=-20A/ $\mu$ s	125	24		50	$\mu$ s
$I_{GT}$	Gate trigger current	$V_A=12V, I_A=1A$	25	40		250	mA
$V_{GT}$	Gate trigger voltage			0.9		2.5	V
$I_H$	Holding current			20		400	mA
$V_{GD}$	Non-trigger gate voltage	$V_{DM}=67\%V_{DRM}$	125	0.3			V
$R_{th(j-h)}$	Thermal resistance Junction to heatsink	At 180° sine, double side cooled Clamping force 15KN				0.035	$^{\circ}C /W$
$F_m$	Mounting force			10		20	KN
$T_{stg}$	Stored temperature			-40		140	$^{\circ}C$
$W_t$	Weight					260	g
Size	Package box size			95 × 95 × 50			mm

**PERFORMANCE CURVES FIGURE**

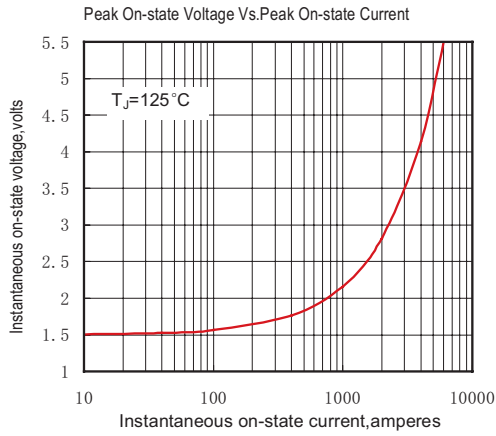

Fig.1

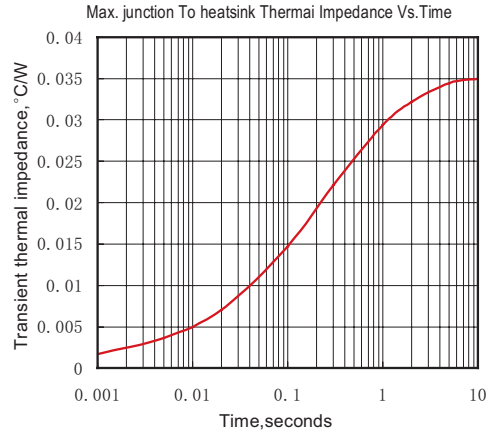

Fig.2

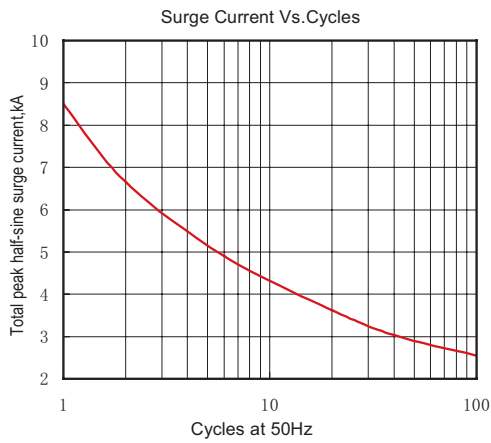

Fig.3

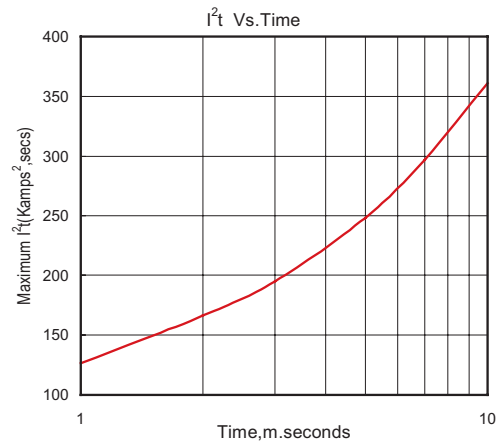

Fig.4

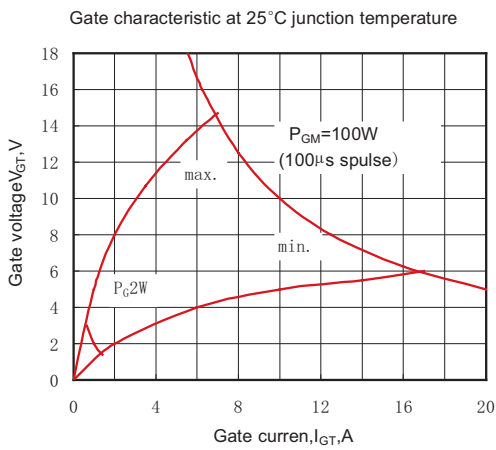

Fig.5

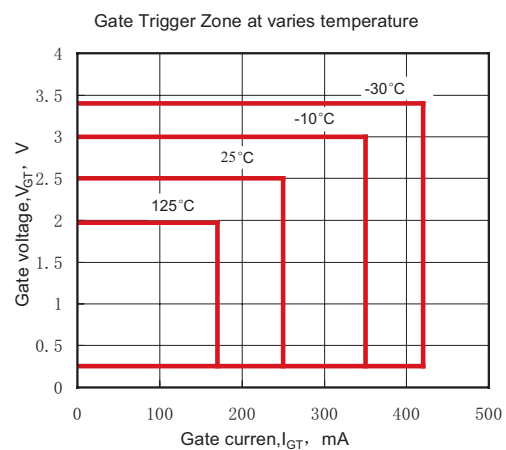
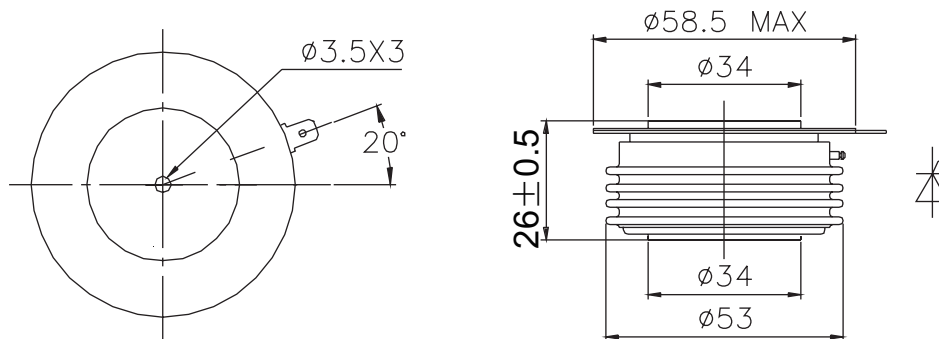

Fig.6

**OUTLINE**



**YUEQING LIUJING RECTIFIER CO., LTD**

Sale Department: Liujing Building, Yueqing City,  
Zhejiang Province

Add: Wanao Industrial Zone, Yueqing city,  
Zhejiang Province

Tel: 0086-577-62519692    0089-577-62519693

Fax: 0086-577-62518692

International Export: 0086-577-62571902

Technical Support: 0086-15868768965

After Service: 400-6606-086

<http://www.china-liujing.com>

<http://www.liujingdianqi.cn>

<http://www.cnrectifier.com>

<http://www.cnthyristor.com.cn>

MSN: [thristors@hotmail.com](mailto:thristors@hotmail.com)

**打造最具竞争力的电力半导体产品**

To be the most competitive Power Semiconductor  
Devices manufactory.

LIUJING reserves the right to change limits, test conditions and dimensions.

윤정은 이 칼타로그 중에 데이트, 테스트 조건, 외형사이즈에 대한 최종 해석권을 가지고 있습니다.