

### FEATURES

- 1). Center amplifying gate
- 2). Metal case with ceramic insulator
- 3). Low on-state and switching losses

### TYPICAL APPLICATIONS

- 1). AC controllers
- 2). DC and AC motor control
- 3). Controlled rectifiers

$I_{T(AV)}$	1900A
$V_{DRM}/V_{RRM}$	400~1000V
$I_{TSM}$	29 KA
$I^2t$	4205 $10^3 A^2S$

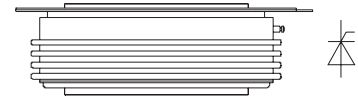

### THE MAIN PARAMETERS

SYMBOL	CHARACTERISTIC	TEST CONDITIONS	$T_j(^{\circ}C)$	VALUE			UNIT
				Min	Type	Max	
$I_{T(AV)}$	Mean on-state current	180° half sine wave 50Hz Double side cooled, $T_{ns}=55^{\circ}C$ $T_{ns}=60^{\circ}C$	125			1900 1800	A
$V_{DRM}$ $V_{RRM}$	Repetitive peak off-state voltage Repetitive peak reverse voltage	$V_{DRM} \& V_{RRM}, tp=10ms$ $V_{DSM} \& V_{RSM} = V_{DRM} \& V_{RRM} + 100V$	125	400		1000	V
$I_{DRM}$ $I_{RRM}$	Repetitive peak off-state current Repetitive peak reverse current	$V_D = V_{DRM}$ $V_R = V_{RRM}$	125			100	mA
$I_{TSM}$	Surge on-state current	10ms half sine wave	125			29	KA
$I^2t$	$I^2T$ for fusing coordination	$V_R = 0.6V_{RRM}$				4205	$A^2s \cdot 10^3$
$V_{TO}$	Threshold voltage		125			0.88	V
$r_T$	On-state slop resistance					0.17	mΩ
$V_{TM}$	Peak on-state voltage	$I_{TM}=4000A, F=26KN$	125			1.80	V
dv/dt	Critical rate of rise of off-state voltage	$V_{DM}=0.67V_{DRM}$	125			1000	V/μs
di/dt	Critical rate of rise of on-state current	$V_{DM}=67\%V_{DRM}$ to 2500A, Gate pulse $t_r \leq 0.5 \mu s, I_{GM}=1.5A$	125			200	A/μs
$I_{rm}$	Reverse recovery current						A
$t_{rr}$	Reverse recovery time	$I_{TM}=1500A, tp=1000 \mu s,$ $di/dt=-20A/\mu s,$ $VR=50V$	125				μs
$Q_{rr}$	Recovery charge						μC
$I_{GT}$	Gate trigger current			40		300	mA
$V_{GT}$	Gate trigger voltage	$V_A=12V, I_A=1A$	25	0.8		3.0	V
$I_H$	Holding current			20		300	mA
$V_{GD}$	Non-trigger gate voltage	$V_{DM}=0.67V_{DRM}$	125	0.3			V
$R_{th(j-h)}$	Thermal resistance Junction to heatsink	At 180° sine, double side cooled Clamping force 26KN				0.022	°C /W
$F_m$	Mounting force			21		30	KN
$T_{stg}$	Stored temperature			-40		140	°C
$W_t$	Weight				620		g
Size	Package box size					160 × 145 × 65	mm

**PERFORMANCE CURVES FIGURE**

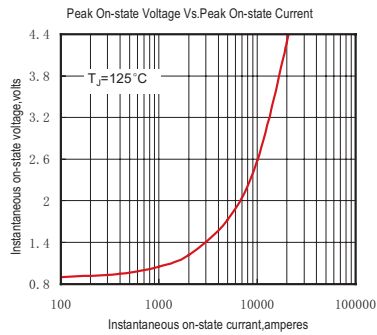

Fig.1

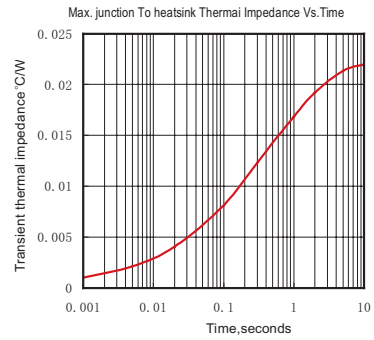

Fig.2

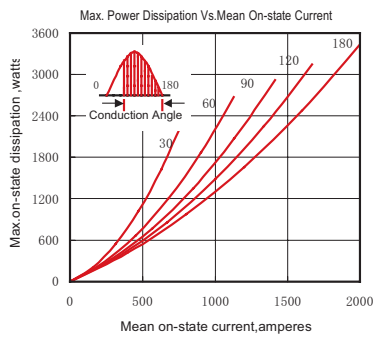

Fig.3

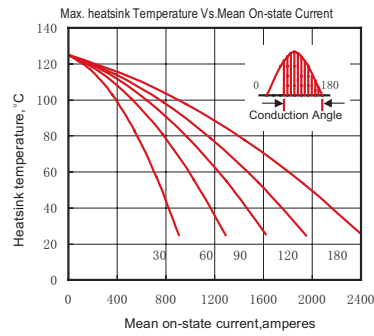

Fig.4

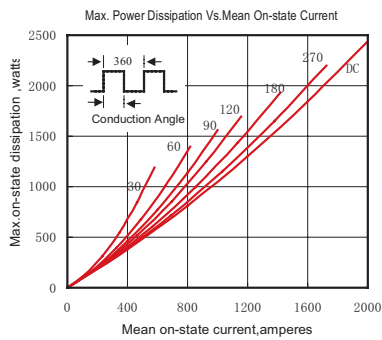

Fig.5

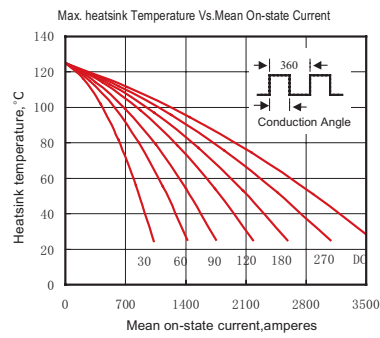

Fig.6

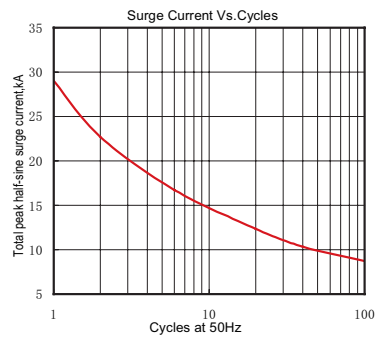

Fig.7

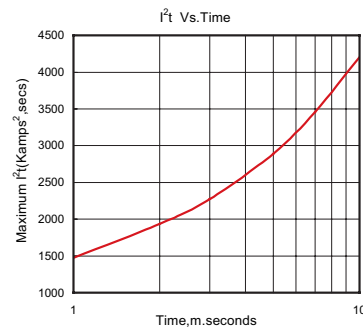

Fig.8

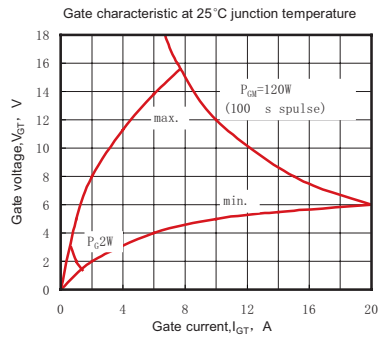

Fig.9

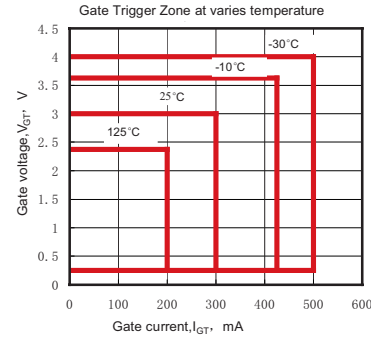
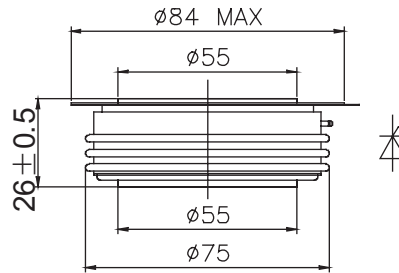
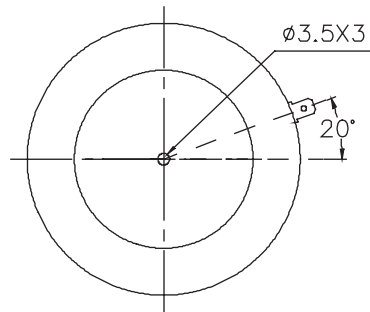

Fig.10

## OUTLINE



### YUEQING LIUJING RECTIFIER CO., LTD

Sale Department: Liujing Building, Yueqing City,  
Zhejiang Province

Add: Wanao Industrial Zone, Yueqing city,  
Zhejiang Province

Tel: 0086-577-62519692    0089-577-62519693

Fax: 0086-577-62518692

International Export: 0086-577-62571902

Technical Support: 0086-15868768965

After Service: 400-6606-086

<http://www.china-liujing.com>

<http://www.liujingdianqi.cn>

<http://www.cnrectifier.com>

<http://www.cnthyristor.com.cn>

MSN: [thristors@hotmail.com](mailto:thristors@hotmail.com)

**打造最具竞争力的电力半导体产品**

To be the most competitive Power Semiconductor  
Devices manufactory.

LIUJING reserves the right to change limits, test conditions and dimensions.

윤정은 이 칼타로그 중에 데이트, 테스트 조건, 외형사이즈에 대한 최종 해석권을 가지고 있습니다.