

FEATURES

- 1). Center amplifying gate
- 2). Metal case with ceramic insulator
- 3). Low on-state and switching losses

TYPICAL APPLICATIONS

- 1). AC controllers
- 2). DC and AC motor control
- 3). Controlled rectifiers

$I_{T(AV)}$ 4755 A
 V_{DRM}/V_{RRM} 1900-3000V
 I_{TSM} 65 KA
 I^2t 21125 $10^3 A^2S$



THE MAIN PARAMETERS

SYMBOL	CHARACTERISTIC	TEST CONDITIONS	$T_j(°C)$	VALUE			UNIT
				Min	Type	Max	
$I_{T(AV)}$	Mean on-state current	180° half sine wave 50Hz Double side cooled, $T_{hs}=55°C$ $T_{hs}=68°C$	125			4755 4000	A
V_{DRM} V_{RRM}	Repetitive peak off-state voltage Repetitive peak reverse voltage	$V_{DRM} \& V_{RRM}, tp=10ms$ $V_{DSM} \& V_{RSM} = V_{DRM} \& V_{RRM} + 100V$	125	1900		3000	V
I_{DRM} I_{RRM}	Repetitive peak off-state current Repetitive peak reverse current	$V_D = V_{DRM}$ $V_R = V_{RRM}$	125			200	mA
I_{TSM}	Surge on-state current	10ms half sine wave	125			65	KA
I^2t	I^2T for fusing coordination	$V_R = 0.6V_{RRM}$	125			21125	$A^2s \cdot 10^3$
V_{TO}	Threshold voltage		125			0.91	V
r_T	On-state slop resistance		125			0.09	mΩ
V_{TM}	Peak on-state voltage	$I_{TM}=6000A, F=98KN$	125			1.45	V
dv/dt	Critical rate of rise of off-state voltage	$V_{DM}=0.67V_{DRM}$	125			1000	V/μs
di/dt	Critical rate of rise of on-state current	$V_{DM}=67\%V_{DRM}$ to 4000A, Gate pulse $t_r \leq 0.5 \mu s, I_{GM}=1.5A$	125			250	A/μs
I_{rm}	Reverse recovery current	$I_{TM}=2000A, tp=1000 \mu s,$ $di/dt=-20A/\mu s,$ $VR=50V$	125			250	A
t_{rr}	Reverse recovery time					26	μs
Q_{rr}	Recovery charge					3250	μC
I_{GT}	Gate trigger current	$V_A=12V, I_A=1A$	25	40		450	mA
V_{GT}	Gate trigger voltage			0.9		3.5	V
I_H	Holding current	$V_{DM}=67\%V_{DRM}$	125	20		1000	mA
V_{GD}	Non-trigger gate voltage			0.3			V
$R_{th(j-h)}$	Thermal resistance Junction to heatsink	At 180° sine, double side cooled Clamping force 98KN				0.0075	°C /W
F_m	Mounting force			80		110	KN
T_{stg}	Stored temperature			-40		140	°C
W_t	Weight				2000		g
Size	Package box size			160 × 145 × 65			mm

PERFORMANCE CURVES FIGURE

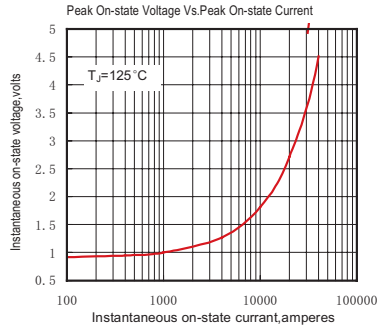

Fig.1

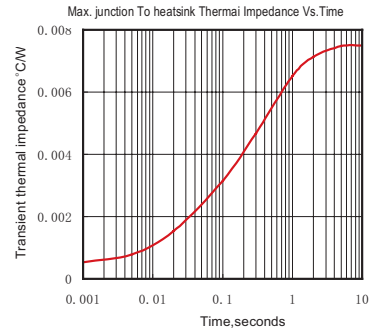

Fig.2

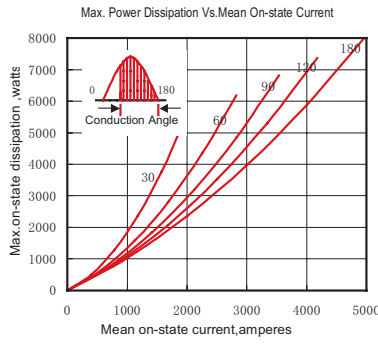

Fig.3

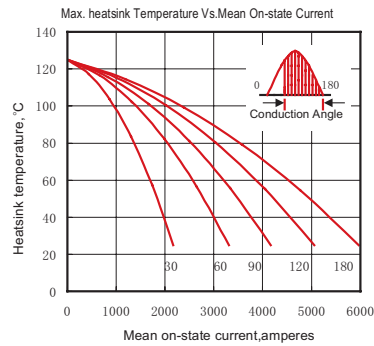

Fig.4

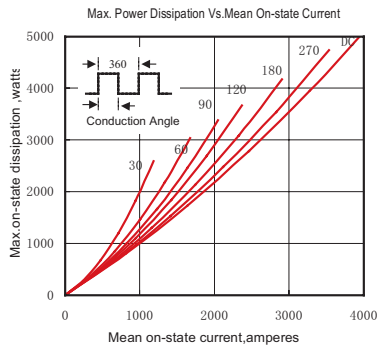

Fig.5

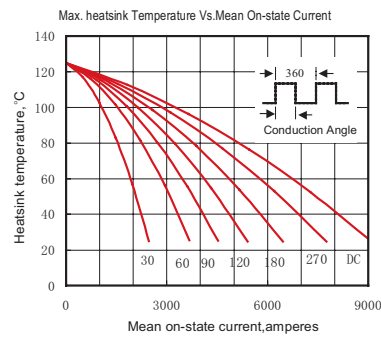

Fig.6

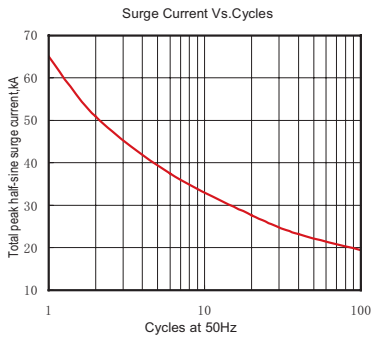

Fig.7

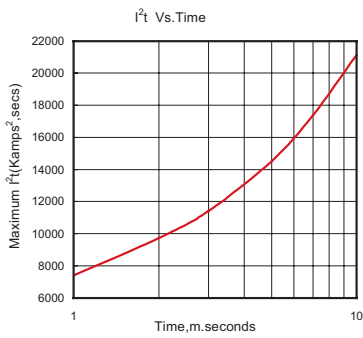

Fig.8

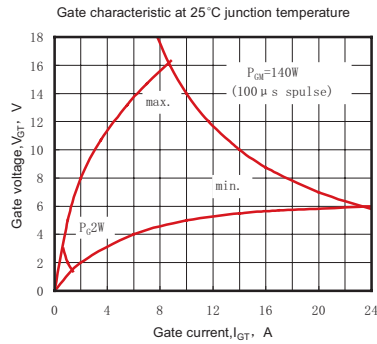

Fig.9

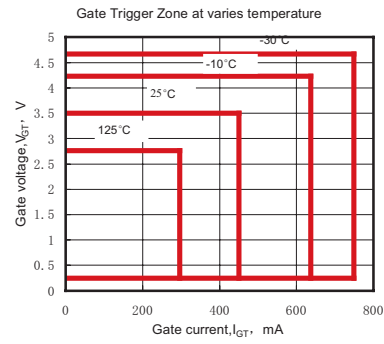
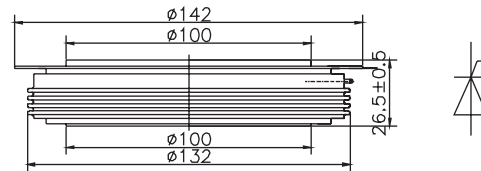
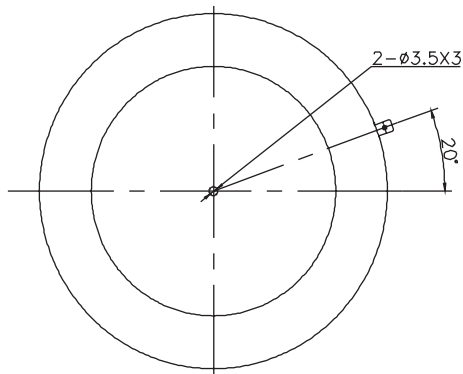

Fig.10

OUTLINE



YUEQING LIUJING RECTIFIER CO., LTD

Sale Department: Liujing Building, Yueqing City, Zhejiang Province
 Add: Wanao Industrial Zone, Yueqing city, Zhejiang Province
 Tel: 0086-577-62519692 0089-577-62519693
 Fax: 0086-577-62518692
 International Export: 0086-577-62571902
 Technical Support: 0086-15868768965
 After Service: 400-6606-086
<http://www.china-liujing.com>
<http://www.liujingdianqi.cn>
<http://www.cnrectifier.com>
<http://www.cnthyristor.com.cn>
 MSN: thristors@hotmail.com

打造最具竞争力的电力半导体产品

To be the most competitive Power Semiconductor Devices manufactory.

LIUJING reserves the right to change limits, test conditions and dimensions.

윤정은 이 칼타로그 중에 데이트, 테스트 조건, 외형사이즈에 대한 최종 해석권을 가지고 있습니다.