

### 特点

- 1). 扩散结
- 2). 平板型陶瓷管壳结构
- 3). 双面冷却

### 典型应用

- 1). 大功率变流器
- 2). 焊接设备
- 3). 电机控制和驱动

$I_{F(AV)}$	500A
$V_{RRM}$	200~1000V
$I_{FSM}$	7 KA
$I^2t$	250 $10^3 A^2S$

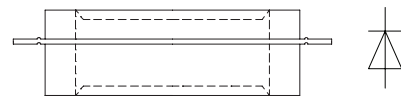

### 主要参数

符号	参数	测试条件	结温 $T_j(^\circ C)$	参数值			单位
				最小	典型	最大	
$I_{F(AV)}$	正向平均电流	180° 正弦半波, 50Hz 双面散热, $T_{hs}=120^\circ C$	150			500	A
$I_{F(AV)}$	正向平均电流	180° 正弦半波, 50Hz 双面散热, $T_{hs}=55^\circ C$	150			1202	A
$V_{RRM}$	反向重复峰值电压	$V_{RRM} \text{ tp}=10\text{ms}, V_{RSM} = V_{RRM} + 100\text{V}$	150	200		1000	V
$I_{RRM}$	反向重复峰值电流	$V_{RM} = V_{RRM}$	150			40	mA
$I_{FSM}$	正向不重复峰值电流	10ms 底宽, 正弦半波	150			7	KA
$I^2t$	浪涌电流平方时间积	$V_R = 0.6V_{RRM}$				250	$A^2s \cdot 10^3$
$V_{FO}$	门槛电压		150			1.06	V
$r_F$	斜率电阻					0.31	$m\Omega$
$V_{FM}$	正向峰值电压	$I_{TM}=1500\text{A}, F=15\text{KN}$	25			1.8	V
$I_{rm}$	反向恢复电压	$I_{TM}=600\text{A}, \text{tp}=1000 \mu s,$					A
$t_{rr}$	反向恢复电流	$di/dt = -20\text{A}/\mu s,$	150				$\mu s$
$Q_{rr}$	恢复电荷	$V_R = 50\text{V}$					$\mu C$
$R_{th(j-h)}$	热阻抗(结至散热器)	180° 正弦波, 双面散热; 压紧力 15KN				0.040	$^\circ C / W$
$F_m$	安装力			10		20	KN
$T_{stg}$	存储温度			-40		160	$^\circ C$
$W_t$	质量				110		g
Size	包装盒尺寸					95 × 95 × 50	mm

性能曲线图

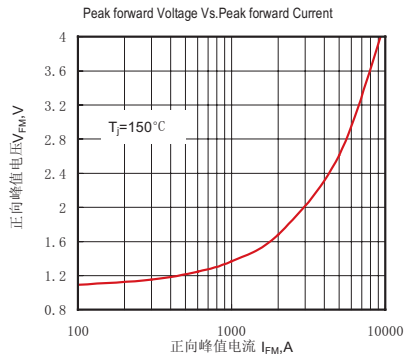

Fig.1 正向伏安特性曲线

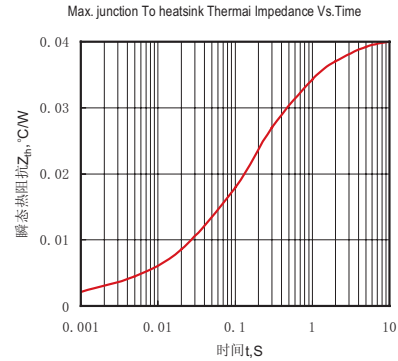

Fig.2 结至散热器瞬态热阻抗曲线

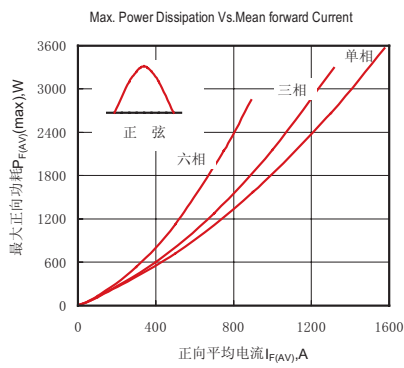

Fig.3最大功耗与正向平均电流关系曲线

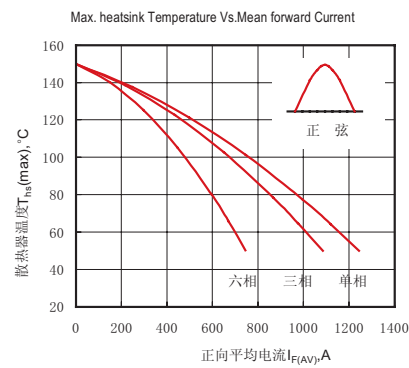

Fig.4散热器温度正向平均电流 关系曲线

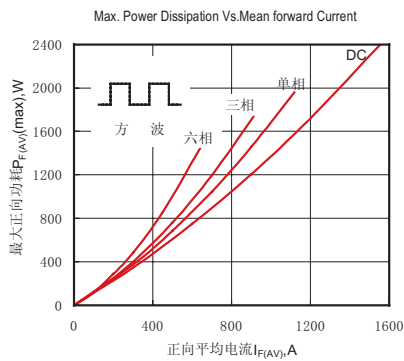

Fig.5最大功耗与正向平均电流关系曲线

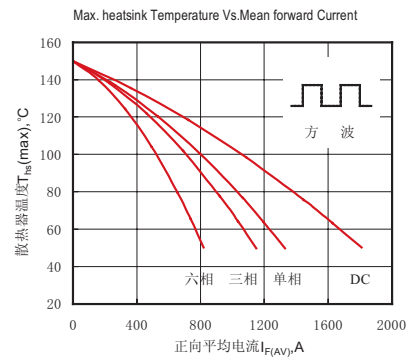

Fig.6散热器温度正向平均电流 关系曲线

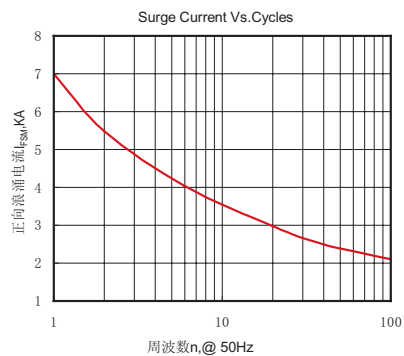

Fig.7 正向浪涌电流与周波数的关系曲线

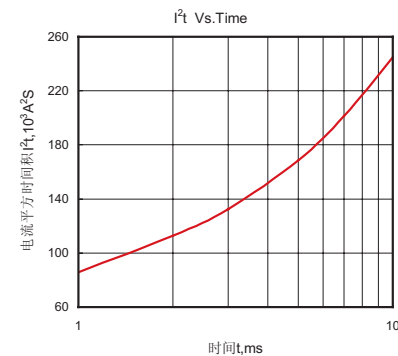
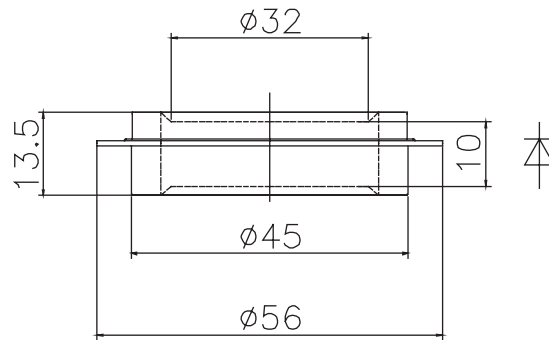

Fig.8 I²t特性曲线

外形尺寸图



**YUEQING LIUJING RECTIFIER CO., LTD**

Sale Department: Liujing Building, Yueqing City,  
Zhejiang Province

Add: Wanao Industrial Zone, Yueqing city,  
Zhejiang Province

Tel: 0086-577-62519692    0089-577-62519693

Fax: 0086-577-62518692

International Export: 0086-577-62571902

Technical Support: 0086-15868768965

After Service: 400-6606-086

<http://www.china-liujing.com>

<http://www.liujingdianqi.cn>

<http://www.cnrectifier.com>

<http://www.cnthyristor.com.cn>

MSN: [thristors@hotmail.com](mailto:thristors@hotmail.com)

**打造最具竞争力的电力半导体产品**

To be the most competitive Power Semiconductor  
Devices manufactory.

LIUJING reserves the right to change limits, test conditions and dimensions.

윤정은 이 칼타로그 중에 데이트, 테스트 조건, 외형사이즈에 대한 최종 해석권을 가지고 있습니다.