

特点

- 1). 扩散结
- 2). 平板型陶瓷管壳结构
- 3). 双面冷却

典型应用

- | | | |
|-------------|-------------|-----------------|
| 1). 大功率变流器 | $I_{F(AV)}$ | 600A |
| 2). 焊接设备 | V_{RRM} | 1100~2000V |
| 3). 电机控制和驱动 | I_{FSM} | 8.4 KA |
| | I^2t | 350 $10^3 A^2S$ |

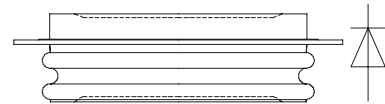

主要参数

符号	参数	测试条件	结温	参数值			单位
			$T_j(^\circ C)$	最小	典型	最大	
$I_{F(AV)}$	正向平均电流	180° 正弦半波, 50Hz, 双面散热, $T_{hs}=124^\circ C$	150			600	A
$I_{F(AV)}$	正向平均电流	180° 正弦半波, 50Hz, 双面散热, $T_{hs}=55^\circ C$	150			1562	A
V_{RRM}	反向重复峰值电压	$V_{RRM} tp=10ms, V_{RSM}=V_{RRM}+100V$	150	1100		2000	V
I_{RRM}	反向重复峰值电流	$V_{RM}=V_{RRM}$	150			40	mA
I_{TSM}	正向不重复浪涌电流	10ms 底宽, 正弦半波, $V_R=0.6V_{RRM}$	150			8.4	KA
I^2t	浪涌电流平方时间积					350	$A^2s \cdot 10^3$
V_{FO}	门槛电压		150			0.93	V
r_F	斜率电阻					0.21	mΩ
V_{FM}	正向峰值电压	$I_{TM}=1800A, F=18KN$	25			1.8	V
I_{rm}	恢复电流	$I_{TM}=600A, tp=1000 \mu s,$ $-di/dt=20A/\mu s,$ $V_R=50V$	150				A
t_{rr}	恢复时间						μs
$R_{th(j-h)}$	恢复电荷						μC
F_m	热阻抗(结至散热器)	180° 正弦波, 双面散热, 安装力18KN				0.035	$^\circ C/W$
	安装力			15		20	KN
T_{stg}	存储温度			-40		160	$^\circ C$
W_t	质量				200		g
Size	包装盒尺寸		95 × 95 × 50				mm

性能曲线图

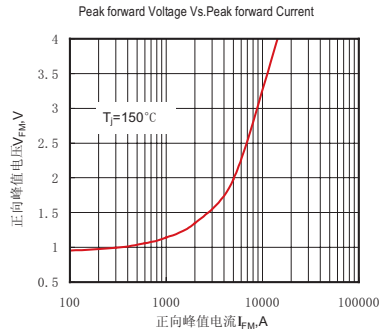

Fig.1 正向伏安特性曲线

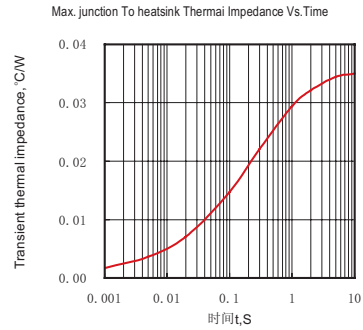

Fig.2 结至散热器瞬态热阻抗曲线

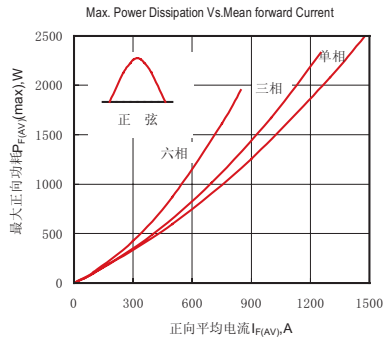

Fig.3 最大功耗与正向平均电流关系曲线

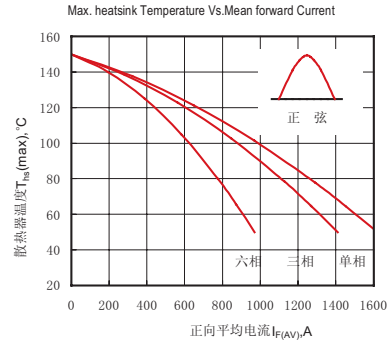

Fig.4 散热器温度正向平均电流 关系曲线

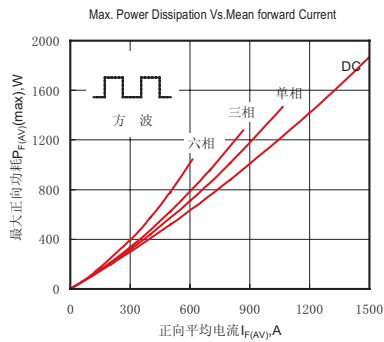

Fig.5 最大功耗与正向平均电流关系曲线

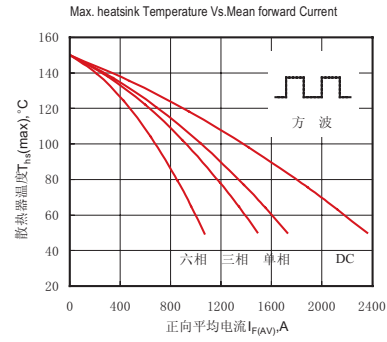

Fig.6 散热器温度正向平均电流 关系曲线

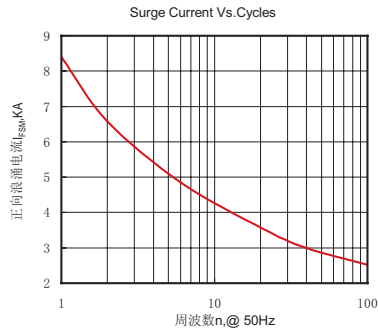

Fig.7 正向浪涌电流与周波数的关系曲线

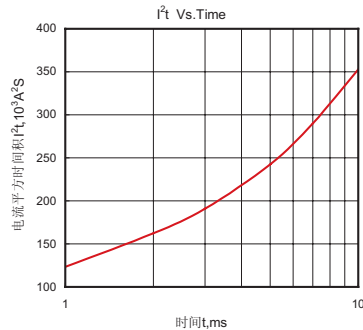
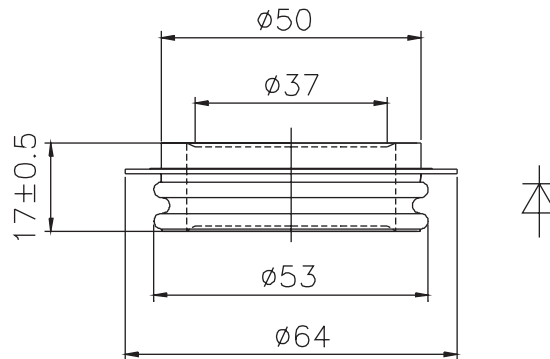

Fig.8 I²t特性曲线

外形尺寸图



YUEQING LIUJING RECTIFIER CO., LTD

Sale Department: Liujing Building, Yueqing City,
Zhejiang Province

Add: Wanao Industrial Zone, Yueqing city,
Zhejiang Province

Tel: 0086-577-62519692 0089-577-62519693

Fax: 0086-577-62518692

International Export: 0086-577-62571902

Technical Support: 0086-15868768965

After Service: 400-6606-086

<http://www.china-liujing.com>

<http://www.liujingdianqi.cn>

<http://www.cnrectifier.com>

<http://www.cnthyristor.com.cn>

MSN: thristors@hotmail.com

打造最具竞争力的电力半导体产品

To be the most competitive Power Semiconductor
Devices manufactory.

LIUJING reserves the right to change limits, test conditions and dimensions.

윤정은 이 칼타로그 중에 데이트, 테스트 조건, 외형사이즈에 대한 최종 해석권을 가지고 있습니다.