

### FEATURES

- 1). Low forward voltage drop
- 2). High reverse voltage
- 3). Hermetic metal cases with ceramic insulators

### TYPICAL APPLICATIONS

- 1). All purpose high power rectifier diodes
- 2). High power resistance welding equipment
- 3). Non-controllable and half-controllable rectifiers
- 4). Controlled rectifiers

$I_{F(AV)}$	2065 A
$V_{RRM}$	200~1000 V
$I_{FSM}$	18 KA
$I^2t$	$1620 \cdot 10^3 A^2S$

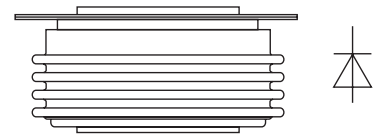

### THE MAIN PARAMETERS

SYMBOL		TEST CONDITIONS	$T_j(^{\circ}C)$	VALUE			UNIT
				Min	Type	Max	
$I_{F(AV)}$	Mean forward current	180° half sine wave 50Hz Double side cooled, $T_{hs}=55^{\circ}C$ $T_{hs}=157^{\circ}C$	190			2065 800	A
$V_{RRM}$	Repetitive peak reverse voltage	$V_{RRM}$ tp=10ms, $V_{RSM}=V_{RRM}+100V$	190	200		1000	V
$I_{RRM}$	Repetitive peak current	$V_{RM}=V_{RRM}$	190			40	mA
$I_{FSM}$	Surge on-state current	10ms half sine wave, $V_R=0.6V_{RRM}$	190			18	KA
$I^2t$	$I^2T$ for fusing coordination					1620	$A^2s \cdot 10^3$
$V_{FO}$	Threshold voltage		190			0.81	V
$r_F$	Forward slop resistance					0.23	mΩ
$V_{FM}$	Peak on-state voltage	$I_{TM}=4400A, F=15KN$	190			1.82	V
$I_{rm}$	Reverse recovery current					90	A
$t_{rr}$	Reverse recovery time	$I_{TM}=1500A, tp=1000 \mu s, di/dt=-20A/\mu s, V_R=50V$	190			4.2	μs
$Q_{rr}$	Recovery charge					189	μC
$R_{th(j-h)}$	Thermal resistance Junction to heatsink	At 180° sine, double side cooled Clamping force 15.0KN				0.033	°C /W
$F_m$	Mounting force			10		20	KN
$T_{stg}$	Stored temperature			-40		200	°C
$W_t$	Weight				270		g
Size	Package box size					95 × 95 × 50	mm

**PERFORMANCE CURVES FIGURE**

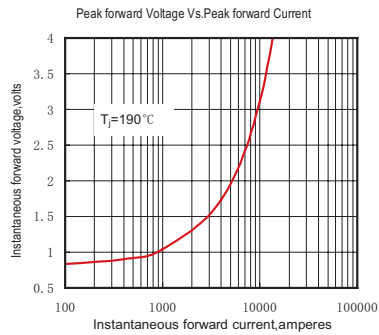

Fig.1

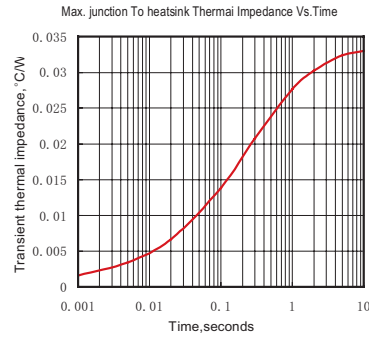

Fig.2

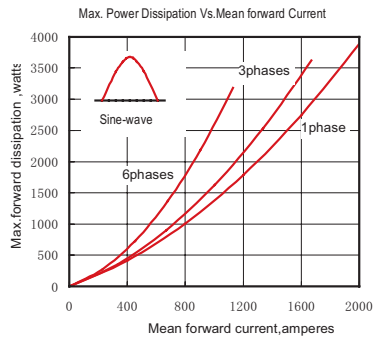

Fig.3

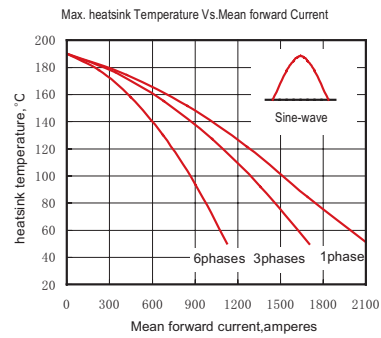

Fig.4

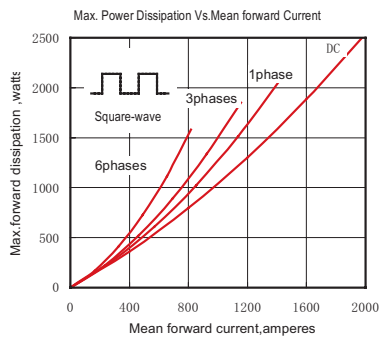

Fig.5

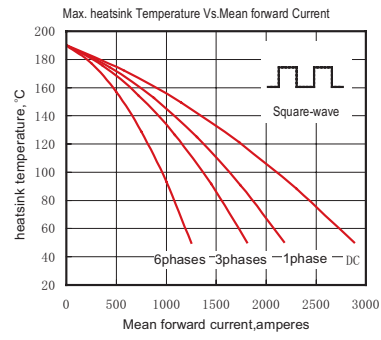

Fig.6

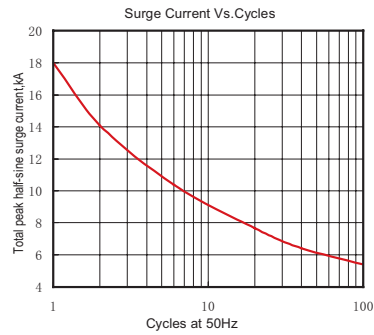

Fig.7

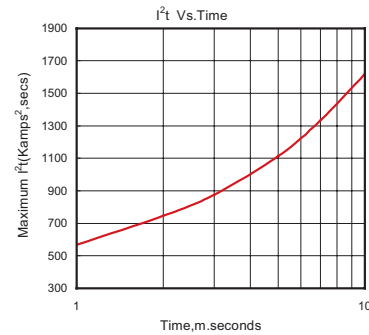
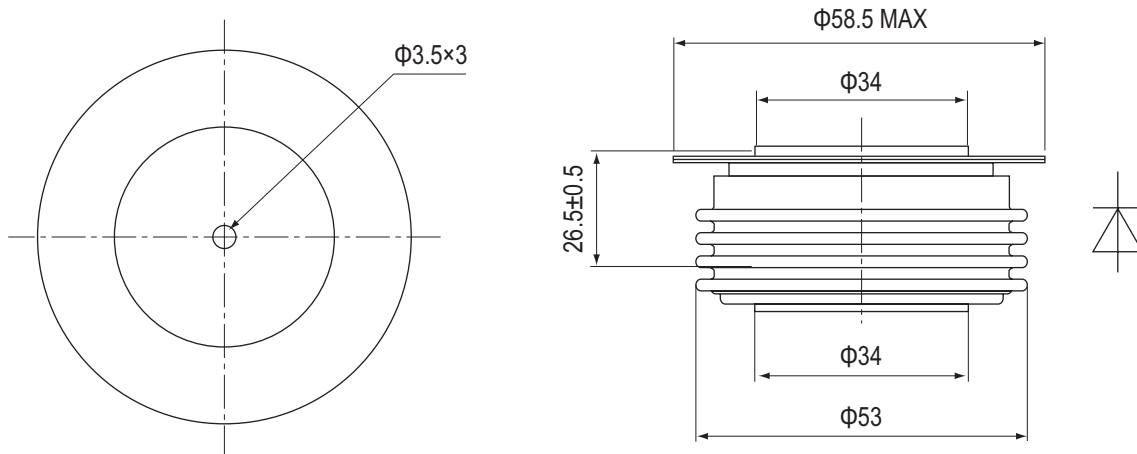

Fig.8

**OUTLINE**



**YUEQING LIUJING RECTIFIER CO., LTD**

Sale Department: Liuqing Building, Yueqing City,  
Zhejiang Province

Add: Wanao Industrial Zone, Yueqing city,  
Zhejiang Province

Tel: 0086-577-62519692    0089-577-62519693

Fax: 0086-577-62518692

International Export: 0086-577-62571902

Technical Support: 0086-15868768965

After Service: 400-6606-086

<http://www.china-liujing.com>

<http://www.liujingdianqi.cn>

<http://www.cnrectifier.com>

<http://www.cnthyristor.com.cn>

MSN: thristors@hotmail.com

**打造最具竞争力的电力半导体产品**

To be the most competitive Power Semiconductor  
Devices manufactory.

LIUJING reserves the right to change limits, test conditions and dimensions.

윤정은 이 칼타로그 중에 데이터, 테스트 조건, 외형사이즈에 대한 최종 해석권을 가지고 있습니다.