

### FEATURES

- 1). Low forward voltage drop
- 2). Soft recovery
- 3). Hermetic metal cases with ceramic insulators

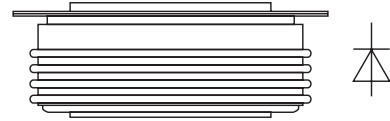

### TYPICAL APPLICATIONS

- |                                      |             |             |
|--------------------------------------|-------------|-------------|
| 1). Inverters and choppers           | $I_{F(AV)}$ | 2016A       |
| 2). AC. motor control                | $V_{RRM}$   | 200~1000V   |
| 3). Snubber and free-wheeling diodes | $t_{rr}$    | 4.0 $\mu$ s |

### THE MAIN PARAMETERS

SYMBOL	CHARACTERISTIC	TEST CONDITIONS	$T_j(^{\circ}C)$	VALUE			UNIT
				Min	Type	Max	
$I_{F(AV)}$	Mean forward current	180° half sine wave 50Hz Double side cooled, $T_{hs}=55^{\circ}C$	150			2016	A
$I_{F(AV)}$	Mean forward current	180° half sine wave 50Hz Double side cooled, $T_{hs}=82^{\circ}C$	150			1600	A
$V_{RRM}$	Repetitive peak reverse voltage	$V_{RRM}$ tp=10ms, $V_{RSM} = V_{RRM} + 100V$	150	200		1000	V
$I_{RRM}$	Repetitive peak current	$V_{RM} = V_{RRM}$	150			80	mA
$I_{FSM}$	Surge forward current					20	KA
$I^2t$	$I^2T$ for fusing coordination	10ms half sine wave, $V_R = 0.6V_{RRM}$	150			2000	$A^2s \cdot 10^3$
$V_{FO}$	Threshold voltage		150			1.15	V
$r_F$	Forward slop resistance					0.20	m $\Omega$
$V_{FM}$	Peak on-state voltage	$I_{TM} = 3000A$ , $F = 24KN$	25			2.8	V
$I_{rm}$	Reverse recovery current					63	A
$t_{rr}$	Reverse recovery time	$I_{TM} = 1000A$ , tp=1000 $\mu$ s, -di/dt=-20A/ $\mu$ s, $V_R = 50V$	100			4	$\mu$ s
$Q_{rr}$	Recovery charge					126	$\mu$ C
$R_{th(j-h)}$	Thermal resistance Junction to heatsink	At 180° sine, double side cooled Clamping force 24KN				0.022	$^{\circ}C / W$
$F_m$	Mounting force			19		26	KN
$T_{stg}$	Stored temperature			-40		160	$^{\circ}C$
$W_t$	Weight					470	g
Size	Package box size	160 × 145 × 65					mm

**OUTLINE**

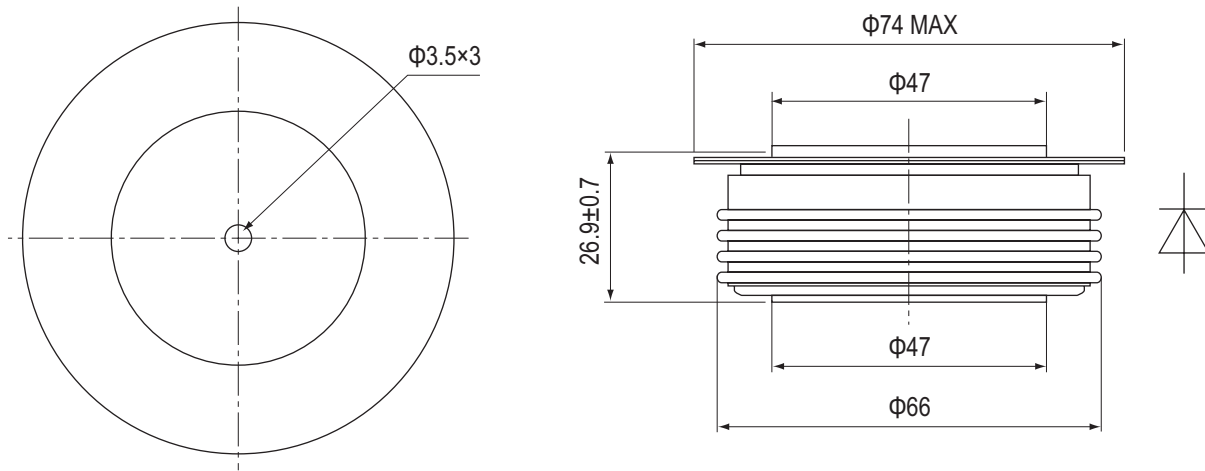

**YUEQING LIUJING RECTIFIER CO., LTD**

Sale Department: Liujiing Building, Yueqing City,  
Zhejiang Province

Add: Wanao Industrial Zone, Yueqing city,  
Zhejiang Province

Tel: 0086-577-62519692    0089-577-62519693

Fax: 0086-577-62518692

International Export: 0086-577-62571902

Technical Support: 0086-15868768965

After Service: 400-6606-086

<http://www.china-liujiing.com>

<http://www.liujiingdianqi.cn>

<http://www.cnrectifier.com>

<http://www.cnthyristor.com.cn>

MSN: [thristors@hotmail.com](mailto:thristors@hotmail.com)

**打造最具竞争力的电力半导体产品**

To be the most competitive Power Semiconductor  
Devices manufactory.

LIUJING reserves the right to change limits, test conditions and dimensions.

윤정은 이 칼타로그 중에 데이트, 테스트 조건, 외형사이즈에 대한 최종 해석권을 가지고 있습니다.