

FEATURES

- 1). Reverse voltages up to 1800V
- 2). Hermetic metal case with glass insulator
- 3). Threaded stud ISO M12, M16 × 1.5
- 4). SKN: anode to stud

MAJOR RATINGS AND CHARACTERISTICS

V_{RSM}	V_{RRM}	$I_{FRMS}=200A$ (maximum value for continuous operation) $I_{FAV}=100A$ (sin. 180° ; $T_C=120^{\circ}C$)
V	V	
400	400	SKN 100/04
800	800	SKN 100/08
1200	1200	SKN 100/12
1400	1400	SKN 100/14
1600	1600	SKN 100/16
1800	1800	SKN 100/18

TYPICAL APPLICATIONS

- 1). All-purpose mean power rectifier diodes
- 2). Cooling via heatsinks
- 3). Non-controllable and half-controllable rectifiers
- 4). Free-wheeling diodes
- 5). Recommended snubber network:
RC: 0.25 μ F, 50 Ω ($P_R=2W$),
 $R_p=50K \Omega$ ($P_R=20W$)

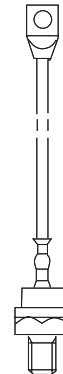

ELECTRICAL SPECIFICATIONS

Symbol	Conditions	Values	V
I_{FAV}	sin. 180; $T_C=100^{\circ}C$	125	A
I_D	K 1.1; $T_a=45^{\circ}C$; B2/B6	140/204	A
	K 1.1F; $T_a=35^{\circ}C$; B2/B6	240/336	A
I_{FSM}	$T_{vj}=25^{\circ}C$; 10ms	1750	A
	$T_{vj}=180^{\circ}C$; 10ms	1500	A
I^2t	$T_{vj}=25^{\circ}C$; 8,3 ... 10ms	15000	A ₂ S
	$T_{vj}=180^{\circ}C$; 8,3 ... 10ms	11500	A ₂ S
V_F	$T_{vj}=25^{\circ}C$; $I_F=400A$	max. 1.55	V
$V_{(TO)}$	$T_{vj}=180^{\circ}C$	max. 0.85	V
r_T	$T_{vj}=180^{\circ}C$	max. 1.8	m Ω
I_{RD}	$T_{vj}=180^{\circ}C$; $V_{RD}=V_{RRM}$	max. 15	mA
Q_{rr}	$T_{vj}=160^{\circ}C$; $-di_F/dt=10A \mu s$	100	μC
$R_{th(j-c)}$		0.45	K/W
$R_{th(c-s)}$		0.08	K/W
T_{vj}		-40 ... +180	$^{\circ}C$
T_{stg}		-55 ... +180	$^{\circ}C$

Symbol	Conditions	Values	V
V_{isol}		-	V~
M_s	to heatsink	10	Nm
a		5*9.81	m/s ²
m	approx.	100	g
Case		E13	

PERFORMANCE CURVES FIGURE

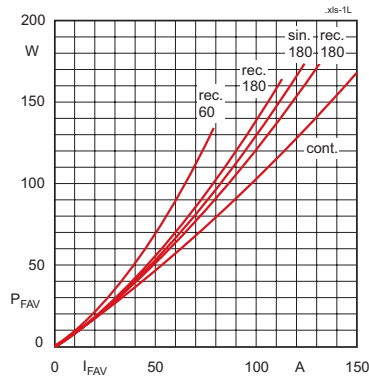

Fig. 1L Power dissipation vs. forward current

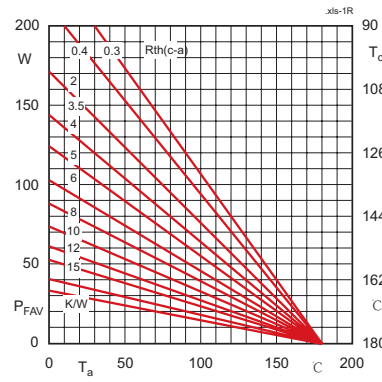

Fig. 1R Power dissipation vs. ambient temperature

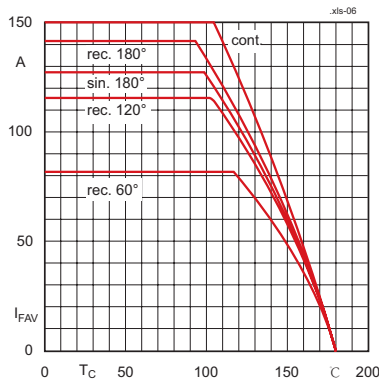

Fig. 2 Forward current vs. case temperature

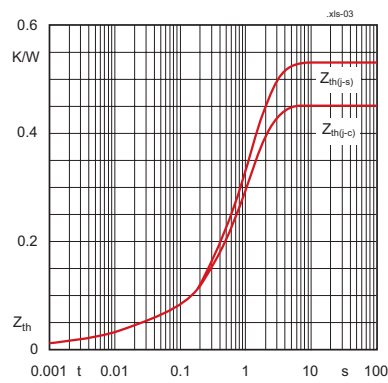

Fig. 4 Transient thermal impedance vs. time

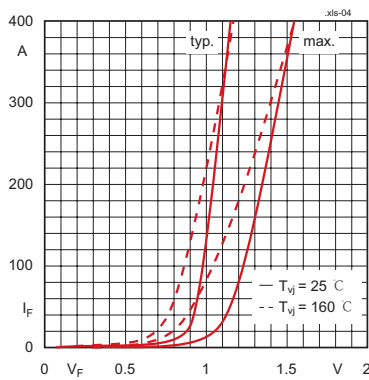

Fig. 5 Forward characteristics

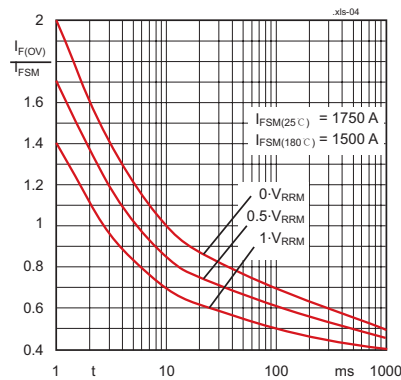
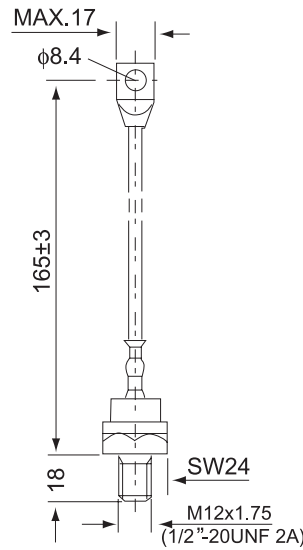

Fig. 6 Surge overload current vs. time

OUTLINE



SKD8

YUEQING LIUJING RECTIFIER CO., LTD

Sale Department: Liuqing Building, Yueqing City,
Zhejiang Province

Add: Wanao Industrial Zone, Yueqing city,
Zhejiang Province

Tel: 0086-577-62519692 0089-577-62519693

Fax: 0086-577-62518692

International Export: 0086-577-62571902

Technical Support: 0086-15868768965

After Service: 400-6606-086

<http://www.china-liujing.com>

<http://www.liujingdianqi.cn>

<http://www.cnrectifier.com>

<http://www.cnthyristor.com.cn>

MSN: thristors@hotmail.com

打造最具竞争力的电力半导体产品

To be the most competitive Power Semiconductor
Devices manufactory.

LIUJING reserves the right to change limits, test conditions and dimensions.

윤정은 이 칼타로그 중에 데이트, 테스트 조건, 외형사이즈에 대한 최종 해석권을 가지고 있습니다.