

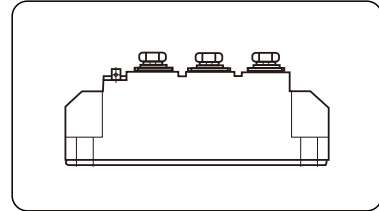

### 特点

- 1). 芯片与底板电气绝缘, 2500V交流电压
- 2). 优良的温度特性和功率循环能力
- 3). 低正向压降
- 4). 高浪涌电流
- 5). 最高工作结温达160°C
- 6). 体积小, 重量轻



### 典型应用

- |                    |   |
|--------------------|---|
| 1). 仪器设备的直流电源      | $I_o$ 70A                                   |
| 2). PWM 变频器的输入整流电源 | $V_{RRM}$ 400-2000V                         |
| 3). 逆变焊机           | $I_{FSM}$ 1.80KA                            |
| 4). 直流电机励磁电源       | $i^2t$ 16.2A <sup>2</sup> S*10 <sup>3</sup> |
| 5). 开关电源的输入整流      | 7). 电气拖动和辅助电流                               |
| 6). 软起动电容充电        | 8). 电池充电直流电源                                |

### 主要参数

符号	参数	测试条件	结温	参数值			单位
			$T_j$ (°C)	最小	典型	最大	
$I_{F(AV)}$	正向平均电流	180°正弦半波, 50Hz, 单面散热, $T_c = 100^\circ\text{C}$	160			70	A
$I_{F(RMS)}$	方均根电流		160			110	
$V_{RRM}$	反向重复峰值电压	$V_{RRM} \text{ tp}=10\text{ms}, V_{RSM} = V_{RRM} + 200\text{V}$	160	600		2000	V
$I_{RRM}$	反向重复峰值电流	$V_{RM} = V_{RRM}$	160			3	mA
$I_{FSM}$	正向不重复浪涌电流	10ms底宽, 正弦半波, $V_R = 0.6V_{RRM}$	160			1.80	KA
$i^2t$	浪涌电流平方时间积					16.2	A <sup>2</sup> S*10 <sup>3</sup>
$V_{FO}$	门槛电压		160			0.80	V
$r_F$	斜率电阻					2.50	mΩ
$V_{FM}$	正向峰值电压	$I_{FM} = 210\text{A}$	25			1.3	V
$R_{th(j-c)}$	热阻抗(结至散热器)	180°正弦半波, 单面散热				0.57	°C/W
$R_{th(c-h)}$	热阻抗(壳至散)	180°正弦半波, 单面散热				0.2	°C/W
$V_{iso}$	绝缘电压	50Hz, R.M.S., t=1min, Iiso: 1mA(max)		2500			V
$F_m$	安装扭矩(M5)				4		N·m
	安装扭矩(M6)				6		N·m
$T_{stg}$	贮存温度			-40		125	°C
$W_t$	质量	外形为201F			140		g
Size	包装盒尺寸	210×110×42(8只装)					mm

性能曲线图

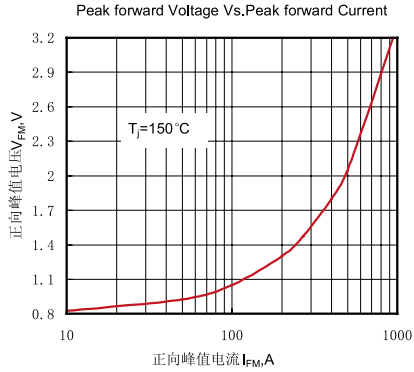

Fig.1 正向伏安特性曲线

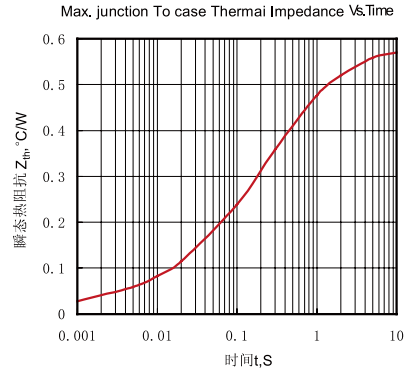

Fig.2 瞬态热阻抗曲线

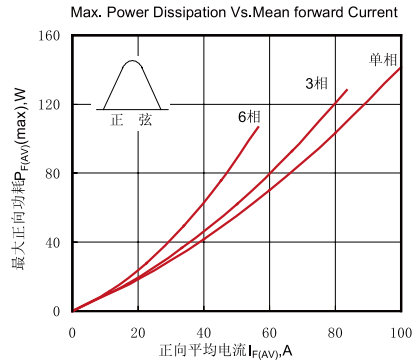

Fig.3 最大正向功耗与平均电流的关系曲线

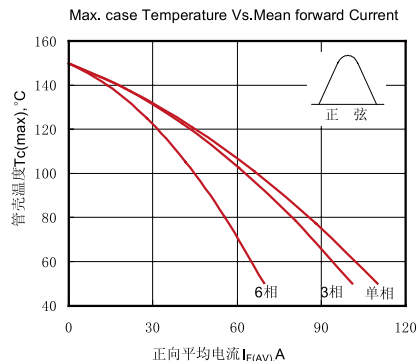

Fig.4 管壳温度与正向平均电流的关系曲线

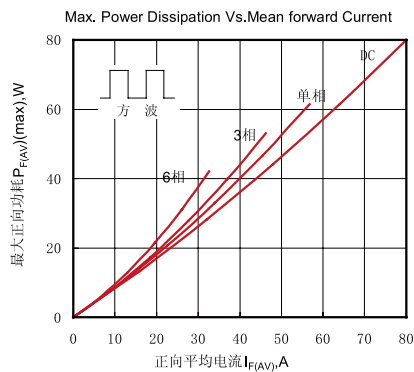

Fig.5 最大正向功耗与平均电流的关系曲线

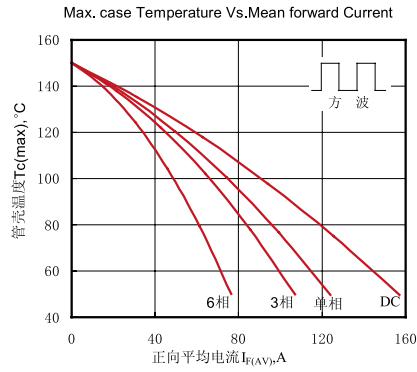

Fig.6 管壳温度与正向平均电流的关系曲线

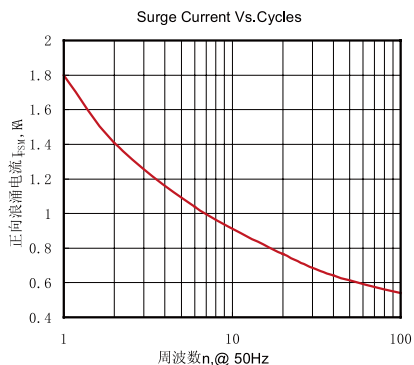

Fig.7 正向浪涌电流与周波数的关系曲线

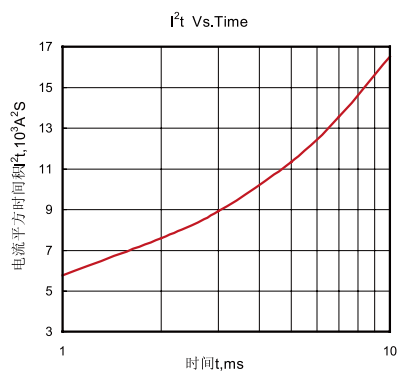
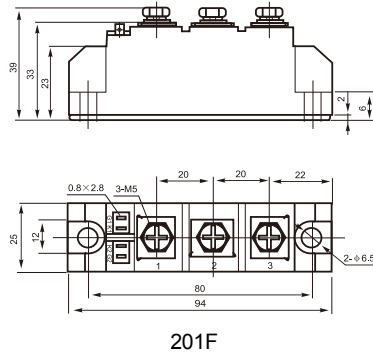

Fig.8 I<sup>2</sup>t特性曲线



外形尺寸图



线路图



4006606086@B.QQ.COM

ZHEJIANG LIUJING RECTIFIER CO., LTD

Sale Department: Liuqing Building, Yueqing City, Zhejiang Province

Add: Wanao Industrial Zone, Yueqing city, Zhejiang Province

Tel: 0086-577-62519692 0089-577-62519693

Fax: 0086-577-61204622

International Export: 0086-577-62571902

Technical Support: 0086-15868768965

After Service: 400-6606-086

http://www.china-liujing.com

http://www.cnthyristor.com

Email:4006606286@B.QQ.COM

打造最具竞争力的电力半导体产品

To be the most competitive Power Semiconductor Devices manufactory.

LIUJING reserves the right to change limits, test conditions and dimensions.

윤정은 이 칼타로그 중에 데이트, 테스트 조건, 외형사이즈에 대한 최종 해석권을 가지고 있습니다.