



LJ-MDK160A

新能源防反二极管模块

Liujing rectifier co., Ltd.

特点

- 1). 芯片与底板电气绝缘, 2500V交流电压
- 2). 优良的温度特性和功率循环能力
- 3). 低正向压降
- 4). 高浪涌电流
- 5). 最高工作结温达160°C
- 6). 体积小, 重量轻

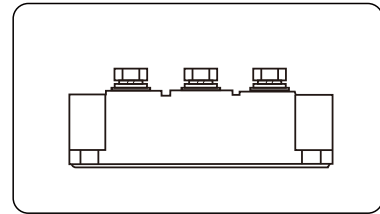

典型应用

- | | |
|--------------------|--|
| 1). 仪器设备的直流电源 | I_O 160A |
| 2). PWM 变频器的输入整流电源 | V_{RRM} 400-2000V |
| 3). 逆变焊机 | I_{FSM} 4.60KA |
| 4). 直流电机励磁电源 | I^2t 106A ² S*10 ³ |
| 5). 开关电源的输入整流 | 7). 电气拖动和辅助电流 |
| 6). 软起动电容充电 | 8). 电池充电直流电源 |

主要参数

符号	参数	测试条件	结温	参数值			单位	
			$T_j(^{\circ}C)$	最小	典型	最大		
$I_{F(AV)}$	正向平均电流	180°正弦半波, 50Hz, 单面散热, $T_c = 100^{\circ}C$	160			160	A	
$I_{F(RMS)}$	方均根电流		160			251		
V_{RRM}	反向重复峰值电压	$V_{RRM} tp = 10ms, V_{RSM} = V_{RRM} + 200V$	160	600		2000	V	
I_{RRM}	反向重复峰值电流	$V_{RM} = V_{RRM}$	160			5	mA	
I_{FSM}	正向不重复浪涌电流	10ms底宽, 正弦半波, $V_R = 0.6V_{RRM}$	160			4.60	KA	
I^2t	浪涌电流平方时间积					106	A ² S*10 ³	
V_{FO}	门槛电压		160			0.80	V	
r_F	斜率电阻					1.35	mΩ	
V_{FM}	正向峰值电压	$I_{FM} = 480A$	25			1.3	V	
$R_{th(j-c)}$	热阻抗(结至散热器)	180°正弦半波, 单面散热				0.23	°C/W	
$R_{th(c-h)}$	热阻抗(壳至散)	180°正弦半波, 单面散热				0.08	°C/W	
V_{iso}	绝缘电压	50Hz, R.M.S., t=1min, Iiso: 1mA(max)		2500			V	
F_m	安装扭矩(M5)				6		N·m	
	安装扭矩(M6)				6		N·m	
T_{stg}	贮存温度			-40		125	°C	
W_t	质量	外形为301F			200		g	
Size	包装盒尺寸	210×110×42(6只装)						mm

性能曲线图

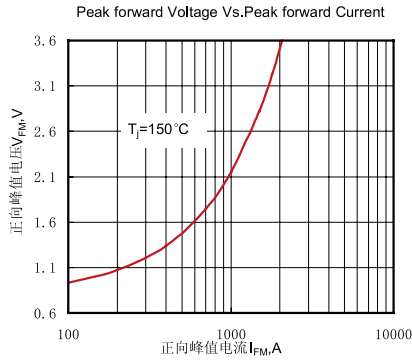

Fig.1 正向伏安特性曲线

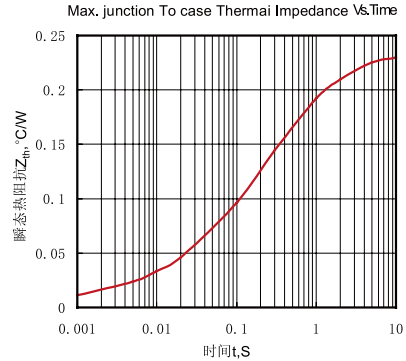

Fig.2 瞬态热阻抗曲线

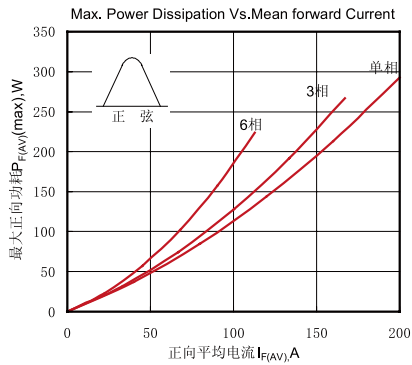

Fig.3 最大正向功耗与平均电流的关系曲线

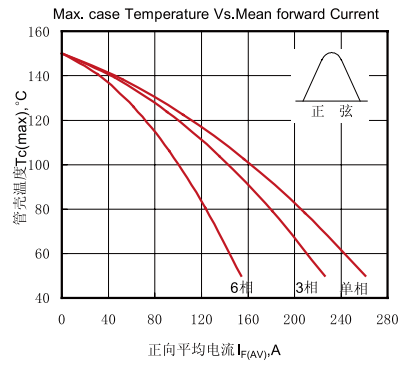

Fig.4 管壳温度与正向平均电流的关系曲线

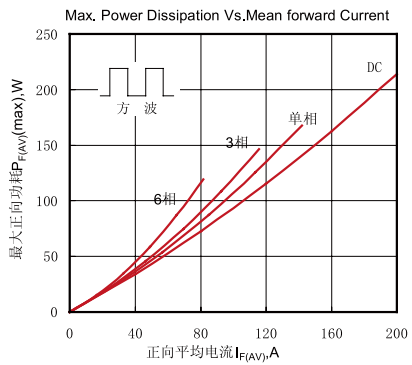

Fig.5 最大正向功耗与平均电流的关系曲线

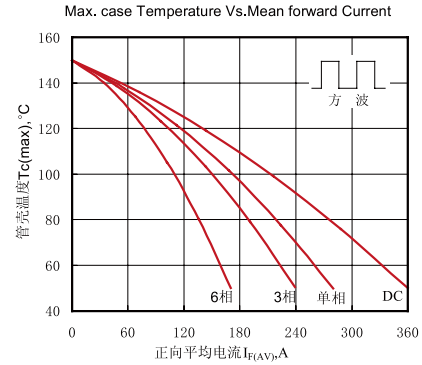

Fig.6 管壳温度与正向平均电流的关系曲线

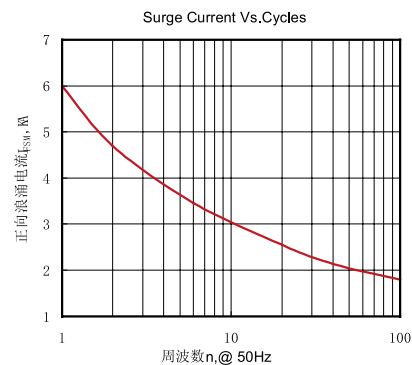

Fig.7 正向浪涌电流与周波数的关系曲线

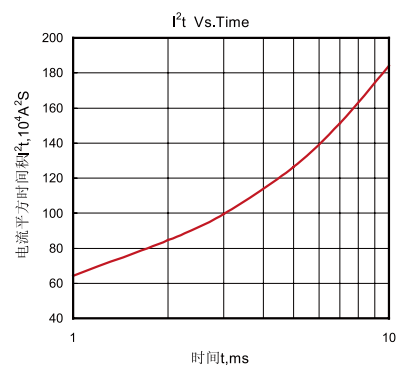
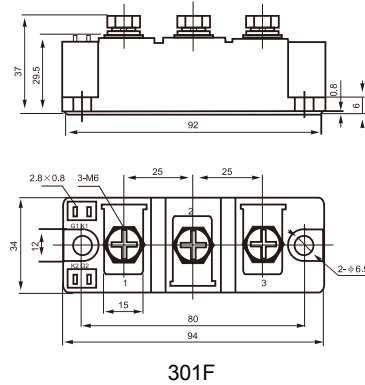

Fig.8 I²t特性曲线



外形尺寸图



线路图

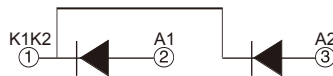

4006606086@B.QQ.COM

ZHEJIANG LIUJING RECTIFIER CO., LTD
Sale Department: Liujing Building, Yueqing City, Zhejiang Province
Add: Wanao Industrial Zone, Yueqing city, Zhejiang Province
Tel: 0086-577-62519692 0089-577-62519693
Fax: 0086-577-61204622
International Export: 0086-577-62571902
Technical Support: 0086-15868768965
After Service: 400-6606-086
http://www.china-liujing.com
http://www.cnthyristor.com
Email:4006606286@B.QQ.COM

打造最具竞争力的电力半导体产品
To be the most competitive Power Semiconductor Devices manufactory.

LIUJING reserves the right to change limits, test conditions and dimensions.
윤정은 이 칼타로그 중에 데이트, 테스트 조건, 외형사이즈에 대한 최종 해석권을 가지고 있습니다.