



LJ-MDC600A

单相整流器模块

Liujing rectifier co., Ltd.

特点

- 1). 芯片与底板电气绝缘, 2500V交流电压
- 2). 优良的温度特性和功率循环能力
- 3). 低正向压降
- 4). 高浪涌电流
- 5). 最高工作结温达150°C
- 6). 体积小, 重量轻

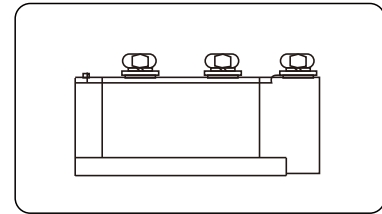

典型应用

- | | |
|--------------------|---|
| 1). 仪器设备的直流电源 | I_o 600A |
| 2). PWM 变频器的输入整流电源 | V_{RRM} 400-2000V |
| 3). 逆变焊机 | I_{FSM} 19KA |
| 4). 直流电机励磁电源 | i^2t 1805A ² S*10 ³ |
| 5). 开关电源的输入整流 | 7). 电气拖动和辅助电流 |
| 6). 软起动电容充电 | 8). 电池充电直流电源 |

主要参数

| 符号 | 参数 | 测试条件 | 结温 | 参数值 | | | 单位 |
|---------------|------------|---|------------------|------|------|-------|----------------------------------|
| | | | $T_j(^{\circ}C)$ | 最小 | 典型 | 最大 | |
| $I_{F(AV)}$ | 正向平均电流 | 180°正弦半波, 50Hz, 单面散热, $T_c = 100^{\circ}C$ | 150 | | | 600 | A |
| $I_{F(RMS)}$ | 方均根电流 | | 150 | | | 942 | |
| V_{RRM} | 反向重复峰值电压 | $V_{RRM} tp=10ms, V_{RSM} = V_{RRM} + 200V$ | 150 | 600 | | 2000 | V |
| I_{RRM} | 反向重复峰值电流 | $V_{RM} = V_{RRM}$ | 150 | | | 40 | mA |
| I_{FSM} | 正向不重复浪涌电流 | 10ms底宽, 正弦半波, $V_R = 0.6V_{RRM}$ | 150 | | | 19 | KA |
| i^2t | 浪涌电流平方时间积 | | | | | 1805 | A ² S*10 ³ |
| V_{FO} | 门槛电压 | | 150 | | | 0.75 | V |
| r_F | 斜率电阻 | | | | | 0.32 | mΩ |
| V_{FM} | 正向峰值电压 | $I_{FM} = 1800A$ | 25 | | | 1.65 | V |
| $R_{th(j-c)}$ | 热阻抗(结至散热器) | 180°正弦半波, 单面散热 | | | | 0.065 | °C/W |
| $R_{th(c-h)}$ | 热阻抗(壳至散) | 180°正弦半波, 单面散热 | | | | 0.024 | °C/W |
| V_{iso} | 绝缘电压 | 50Hz, R.M.S., t=1min, Iiso: 1mA(max) | | 3000 | | | V |
| F_m | 安装扭矩(M5) | | | | 12 | | N·m |
| | 安装扭矩(M6) | | | | 6 | | N·m |
| T_{stg} | 贮存温度 | | | -40 | | 125 | °C |
| W_t | 质量 | 外形为601F | | | 1500 | | g |
| Size | 包装盒尺寸 | 155×73×78(1只装) | | | | | mm |

性能曲线图

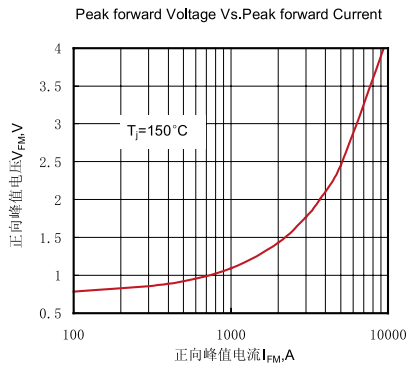

Fig.1 正向伏安特性曲线

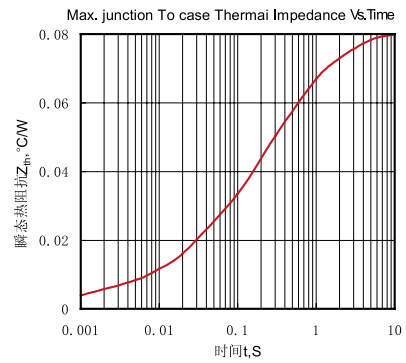

Fig.2 瞬态热阻抗曲线

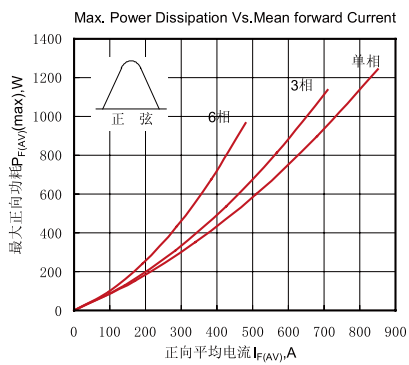

Fig.3最大正向功耗与平均电流的关系曲线

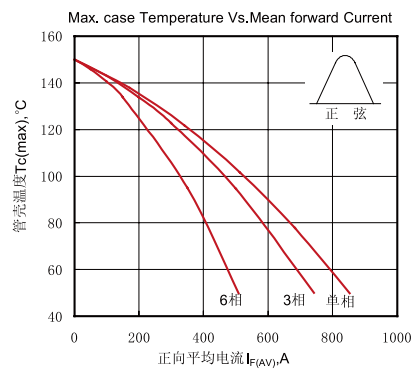

Fig.4管壳温度与正向平均电流的关系曲线

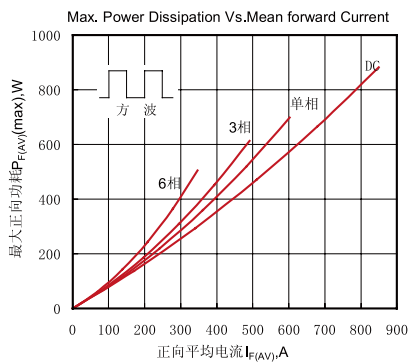

Fig.5最大正向功耗与平均电流的关系曲线

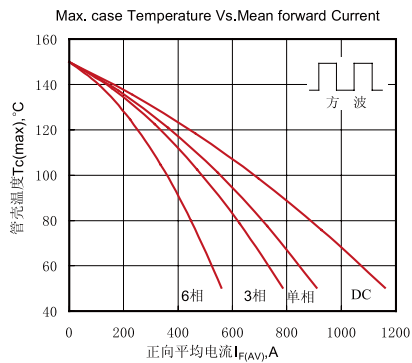

Fig.6管壳温度与正向平均电流的关系曲线

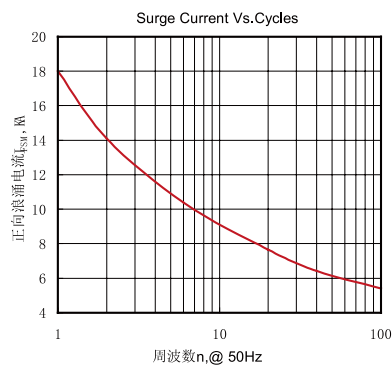

Fig.7 正向浪涌电流与周波数的关系曲线

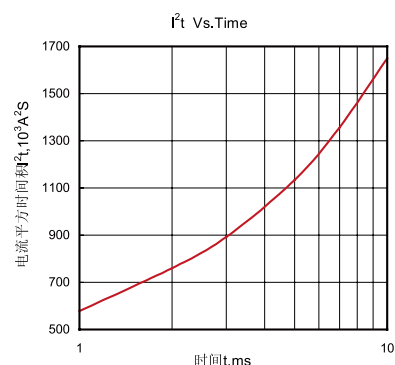
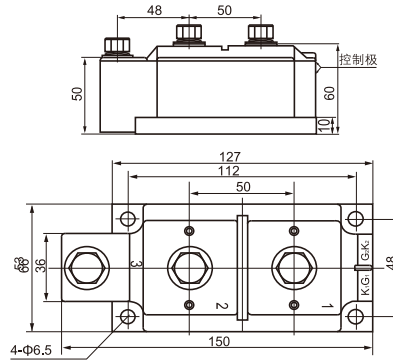

Fig.8 I²t特性曲线



外形尺寸图



601F

线路图

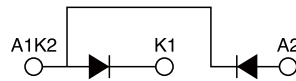

ZHEJIANG LIUJING RECTIFIER CO., LTD

Sale Department: Liuqing Building, Yueqing City, Zhejiang Province

Add: Wanao Industrial Zone, Yueqing city, Zhejiang Province

Tel: 0086-577-62519692 0089-577-62519693

Fax: 0086-577-61204622

International Export: 0086-577-62571902

Technical Support: 0086-15868768965

After Service: 400-6606-086

http://www.china-liujing.com

http://www.cnthyristor.com

Email:4006606286@B.QQ.COM

打造最具竞争力的电力半导体产品

To be the most competitive Power Semiconductor Devices manufactory.

LIUJING reserves the right to change limits, test conditions and dimensions.

윤정은 이 칼타로그 중에 데이트, 테스트 조건, 외형사이즈에 대한 최종 해석권을 가지고 있습니다.